

SF  
531  
A8  
H79  
1911

# Australian Bee Manual



Supplies

SF  
501  
100

ALBERT R. MANN  
LIBRARY

NEW YORK STATE COLLEGES  
OF  
AGRICULTURE AND HOME ECONOMICS

AT  
CORNELL UNIVERSITY



EVERETT FRANKLIN PHILLIPS

BEEKEEPING LIBRARY

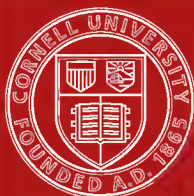

## Cornell University Library

The original of this book is in  
the Cornell University Library.

There are no known copyright restrictions in  
the United States on the use of the text.





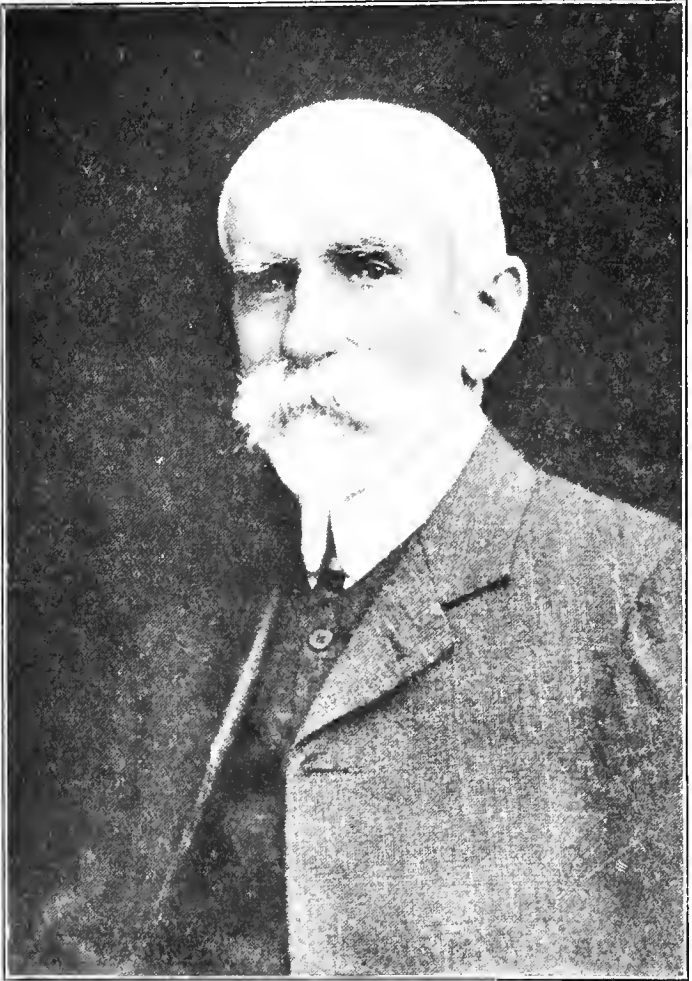

THE AUTHOR.

THE ILLUSTRATED  
**Australasian Bee Manual**

AND COMPLETE  
GUIDE TO MODERN BEE CULTURE  
IN THE  
SOUTHERN HEMISPHERE.

---

By ISAAC HOPKINS, Auckland, New Zealand.  
(Late Chief Apiarist to the New Zealand Government.)

---

WITH WHICH IS INCORPORATED THE  
**“New Zealand Bee Manual”**

REVISED AND MOSTLY RE-WRITTEN  
BY THE AUTHOR.

---

FIFTH EDITION.

82 ILLUSTRATIONS.

---

WELLINGTON, N.Z.

1911

**GORDON & GOTCH**

WELLINGTON, AUCKLAND, CHRISTCHURCH, DUNEDIN, MELBOURNE,  
SYDNEY, BRISBANE, PERTH, HOBART, LAUNCESTON,  
LONDON,

SF  
531  
A8  
H79  
1911

@41215



## PREFACE.

So rapid is the present progress of commercial bee-keeping, necessarily accompanied by frequent changes and modifications in apiary appliances and methods of management, that much of the practical instructions embodied in technical works on bee-culture published from time to time, soon become antiquated, and out of date. I realised this in the present case when commencing to revise the text matter of the last—in preparation for the new—Edition, and therefore I decided to re-write, and re-construct, the whole of the chapters specially dealing with the Manual work of the apiary, and thereby to bring this Edition right up to date. This has been done to the best of my ability, and I trust that the alterations and new matter, together with the additional illustrations, will meet with the approval of those for whom the book is published.

My recent position as Chief Government Apiarist in New Zealand afforded me exceptional opportunities for observing how commercial bee-keeping can be, and is, conducted under different conditions, and by different types of bee-keepers. It also enabled me in the course of my duties to carry out experiments at the Government Apiaries to determine matters of great importance to the industry; some of the results of which have already been published in "Bulletin" No. 18 on Bee-Culture, obtainable from the offices of the Department of Agriculture. The results of the knowledge thus gained are embodied in the present volume.

I would draw special attention to the remarkable progress made in commercial bee-keeping in New Zealand since the Government gave its support to the industry. The passing of our Apiaries Act in 1907 was the one thing needed to bring to the front an industrial

occupation for which the country is so eminently adapted, and which has already given proof of its capacity for great expansion.

The Apiaries Act (see Chapter XVI.) has undoubtedly provided the most effective provisions at present in force in any country for dealing with, and controlling bee diseases, the main feature of which is, making it illegal to keep bees in any other receptacles than movable comb hives.

The result of such legislation has been the clearing of large districts from disease, that up to the passing of the Act were "rotten" with foul brood.

I feel certain that little or no headway against disease can be made in any country unless power is given by legislation to abolish all fixed-comb receptacles as domiciles for bees.

I. HOPKINS.

*Auckland, New Zealand.*

# CONTENTS.

CHAPTER.	PAGE
PREFACE	
I. INTRODUCTORY AND HISTORICAL ... ..	1
II. THE HONEY BEE AND ITS VARIETIES ...	7
III. INMATES OF THE HIVE : THEIR NATURAL HISTORY ... ..	10
IV. WHAT BEES COLLECT AND WHAT THEY PRODUCE ... ..	26
V. THE APIARY ... ..	39
VI. HIVES, FRAMES, AND SECTION BOXES ...	47
VII. COMB FOUNDATION ... ..	65
VIII. THE HONEY EXTRACTOR AND EXTRACTING APPLIANCES ... ..	71
IX. HANDLING BEES ... ..	77
X. TRANSFERRING BEES ... ..	83
XI. INCREASE—NATURAL AND ARTIFICIAL SWARMING ... ..	85
XII. QUEEN REARING ... ..	94
XIII. SURPLUS HONEY ... ..	111
XIV. AUTUMN AND WINTER MANAGEMENT ...	127
XV. DISEASES AND ENEMIES OF BEES ...	134
XVI. THE NEW ZEALAND APIARIES ACT ...	146
XVII. BEE FORAGE—BEES IN RELATION TO HORTICULTURE AND AGRICULTURE ...	149
XVIII. BEES IN RELATION TO AGRICULTURE ...	153
XIX. CALENDAR AND BEE-KEEPER'S AXIOMS ...	166

## LIST OF ILLUSTRATIONS.

FRONTISPIECE: The Author.

FIG.	PAGE	FIG.	PAGE
1. Abdomen of Italian Worker	8	44. Bingham Uncapping Knife...	74
2—3—4. Queen. Drone. Worker	11	45. Dadant Uncapping Can ...	74
5. Head of Worker Bee ...	14	46. Root Cappings Melter ...	75
6. Ovaries of Queen ...	16	47. Bee Veils ...	78
7. From the Egg to the Bee ...	19	48. Corneil Smoker ...	79
8. W. Larvæ and Q. Cells ...	20	49. Vesuvius Smoker ...	79
9. Queen Cells over Worker Cells ...	21	50. Hive Tool ...	81
10. The Sting ...	23	51. Comb Holder ...	82
11. Wax Pockets of Worker Bee	29	52. Wood Cell Cups (cross sections) ...	96
12. Steam Wax Press ...	32	53. Wood Cell Cups Spiked to Frame ...	96
13. Hatch Wax Press ...	33	54. Queen Cell Completed on Wood Base ...	96
14. Solar Wax Extractor ...	35	55. Showing How to Cut the Comb ...	98
15. Drone and Worker Cells ...	37	56. Frame for Raising Queen Cells ...	99
16. Government Apiary ...	41	57. Queen Cell Protector ...	101
17. Ground Plan Extracting House ...	43	58. Alley's Queen Nursery ...	103
18. Hopkins' Langstroth Hive ...	47	59. Alley's Nursery Cage ...	103
19. Langstroth Hive for Comb Honey ...	48	60. Alley's Introducing Cage ...	104
20. End of Hive (Inside View) ...	50	61. Titoff Introducing Cage ...	104
21. End of Hive (Outside View) ...	50	62. Introducing Cage in Use ...	104
22. Side of Hive (Inside View) ...	51	63. Drone and Queen Trap ...	105
23. Putting Parts of Hive Together ...	52	64. Clipping Queen's Wings ...	106
24. Bottom Board ...	53	65. Comb Prepared for Queen Cells ...	109
25. Alighting Board ...	54	66. Comb with Eighty Good Queen Cells ...	110
26. End of Cover ...	55	67. Division Board ...	111
27. Side of Cover ...	55	68. Division Boards in Use ...	112
28. Ridge Board of Cover ...	55	69. Simplicity Feeder ...	114
29. Roof Board of Cover ...	56	70. Doolittle Feeder ...	114
30. Cover Complete ...	56	71. Zinc Excluder ...	116
31. Hopkins' Hive Cramp ...	58	72. Wood and Wire Excluder ...	116
32. Hoffman Brood Frames ...	60	73. Comb Basket ...	118
33. Metal Spaced Frame ...	61	74. Bee Brush ...	119
34. Shallow Hoffman Frame ...	62	75. "Daisy" Wheelbarrow ...	119
35. Half-story Frame with Sections ...	62	76. Honey Tank ...	123
36. One Piece Section Box ...	64	77. Alexander Strainer ...	124
37. Comb Foundation ...	65	78. Porter Bee Escape ...	128
38. Wax T-be Fastener ...	68	79. Portion of Diseased Comb ...	136
39. Wiring Board ...	69	80. Large Wax moth ...	144
40. Spur Wire Embedder ...	70	81. Silken Tube of the Moth Larvæ ...	144
41. Fixed Basket Extractor ...	71		
42. Six-comb Reversible Extractor ...	72		
43. Automatic Reversible Four-comb Extractor ...	73		

## CHAPTER I.

### INTRODUCTORY AND HISTORICAL.

IN the whole range of created objects presented to our contemplation in the study of what we familiarly call NATURE, from the inconceivably great systems of inanimate matter rolling in infinite space to the inconceivably small but animated forms revealed by the microscope, there is probably no class more calculated to excite our wonder and admiration than that of *Insects*; and of all the different kinds of insects there is none more interesting as an object of study, or that can be made more useful and profitable to man, than the Honey-Bee. Its history is as old as that of the human race; its product, honey, was recognised in the earliest ages as a most desirable, almost an indispensable, addition to the food of man.

#### ORIGIN OF THE ART OF BEE-KEEPING.

Though we may never learn when bees were first domesticated in Eastern countries, we do know that amongst the Western nations the civilised Greeks had unquestionably practised the art of bee-keeping at a very early period. The laws of Solon, 600 years B.C., contain regulations as to the distances apart at which bee-hives may be kept; and both Greeks and Romans wrote and sang about bees and bee-keeping from the times of Homer down to those of Aristotle, Virgil, Palladius, Pliny, and Columella.

The true history of the rise and progress of the art of bee-keeping amongst the Greeks and Romans, and its extension over Europe during the middle ages, is as yet unwritten, but there can be no doubt that amongst

the Northern nations the use of honey became with time more and more a matter of necessity, much of their fermented liquors being prepared from it, and the more northern the positions, and the more severe the winter seasons, the more essential it became to domesticate the bees, or use artificial means for preserving them during the winter months. Since the middle of the seventeenth century much attention has been given to the natural history of the bee, and among those who made it their special study were Von Swammerdam, Maraldi, Réaumur, Lepeletier and Latreille, Bonnet, Linnæus, Dr. John Hunter and Dr. Bevan; but it is to the researches and discoveries of Huber and Dzierzon that we are chiefly indebted for that knowledge of the physiology of the honey-bee which has led to those great practical improvements in its management which may be said to constitute the

#### MODERN ART OF BEE-KEEPING.

This may be dated from early in the second half of the nineteenth century, when the movable frame hive in a practicable form was introduced by the Rev. L. L. Langstroth, though it was nearly twenty years after before the industry was thoroughly established on commercial lines. Subsequent to the introduction of the modern hive, the invention of the honey extractor, of comb-foundation, and a number of ingenious implements and appliances, have led to a complete revolution in the practice of bee-keeping, and helped to raise it to the rank of an important national industry, and which is now being fostered by the Governments of nearly all civilised countries.

#### INTRODUCTION OF BEES INTO AUSTRALASIA.

None of the countries of the New World, of North or South America, or of Australasia, were found, when first discovered, to possess any variety of the true honey-bee (*Apis mellifica*); a necessary preliminary,

therefore, to the practice of bee-culture in any of those regions was the introduction of bees from the Old World, an operation which was attended with almost insuperable difficulties sixty or seventy years ago.

I have already placed on record in previous editions of this Manual all particulars with regard to the landing of the first bees in Australia and New Zealand, to which I must refer those who may be particularly interested in the matter. I will now briefly give the dates, and the names of those responsible for their introduction into this part of the world.

The common, or black bee, was introduced into New South Wales from England in April, 1822, by Captain Wallace, of the ship *Isabella*. It is pretty certain that Italian bees were also introduced into that State in 1862, but I have not been able to obtain a sufficiently reliable confirmation of this. So far as I have been able to ascertain, Victoria, South Australia, and Queensland were furnished with common bees from the parent Colony—New South Wales. Dr. Wilson, R.N., introduced the common bee into Tasmania from New South Wales in 1831, and Mr. T. L. Hood, of Hobart, has the credit of landing the first Italian bees in Tasmania, which were brought from the same colony.

Mr. Chas. Fullwood, then of Brisbane, brought Italian bees with him from England in 1880, and this, no doubt, was the first successful attempt made to establish this variety in Australia.

New Zealand is indebted to the late Miss Bumby, sister of one of the early Missionaries, for the first of the common bees, which she brought with her from England in the ship *James*. They were landed at Mangunga, Hokianga, on March 13th, 1839. Others were subsequently brought from England, and New South Wales, in the year 1842. The first Italian bees were landed in Auckland from California, to the order of Mr. J. H. Harrison, then of Coromandel, and to the Author in 1880. In 1883 I imported Italians (direct from Italy), Swiss Alpine, Syrians, Holylanders, Cyprians, and Carniolan bees.

## BEE-KEEPING IN AUSTRALASIA.

The Author had the honour, in the season of 1887-8, of being the first to introduce the Langstroth frame-hive, the improved honey extractor, and comb-foundation into Australasia; and by a series of articles in the Press drew the attention of persons interested in bee culture to the improved system of bee management. Letters were received by me from all parts of the Australasian Colonies, asking for further information, which was subsequently supplied in the first edition of this Manual. It is correct to say then, that what is usually termed the "Modern System" of bee-keeping commenced in Australasia in 1878.

That the climate and flora of this part of the world are eminently adapted for commercial bee-keeping has been abundantly proved, and though we are not entirely free from drawbacks, bee-keepers probably encounter fewer here than those in other countries. There have been difficulties in the past in disposing of Australian honey in Europe at remunerative prices, and I think the prejudice against it had its origin through the want of discrimination on the part of some bee-keepers in sending inferior grades to the Home Markets. I have seen excellent Australian honey, and with a thorough system of Government grading, I have no doubt these difficulties could be largely removed.

Bee-keepers in New Zealand are more fortunate in this respect, their product being in large demand in Europe at good prices.

Great improvements, however, have come about in late years. Much more care is taken in the ripening and preparation of honey for market, the cost of production has been cheapened, more sound knowledge has been gained, and more honey is being used, all of which has made for the betterment of the industry in Australasia. Legislation against bee-diseases in New Zealand has done wonders for commercial bee-keeping in this Dominion, and with prospective similar legisla-



tion in the Australian States, there is a better outlook than ever before for bee-keeping in this part of the world.

#### PROFITS OF BEE-KEEPING.

The question as to the average annual profit that may be expected from each hive is very frequently asked by those who contemplate going into bee-keeping largely. It is easy to show what results are attained in some cases, but it would be dangerous to apply such results as a measure of success or failure to every case. So much depends upon the skill and perseverance of the apiarist, the location of the apiary, and the commercial ability brought to bear in the management, that it is necessary to be very guarded in one's reply. Under favourable conditions with regard to locality and bee forage, a reasonable sized apiary, and a skilful and persevering man in charge, an annual average net profit of from 17/- to £1 may be expected per colony. This is the estimate I gave in my Government Bulletin, and I consider it well within the mark, and, also, applicable under similar conditions to the bee-keeping centres of Australia.

It is a rule, without exception in bee-keeping, that with largely increased operations, and the establishment of out-apiaries, the average profit per hive diminishes. No doubt this may be accounted for by the inability of the apiarist to give each individual colony so large a share of attention.

#### ADVICE TO BEGINNERS.

Bee-keeping is suitable to either sex, and I would strongly advise all young people contemplating taking it up as a business to engage for a full season with a successful bee-farmer, starting early in the season, and remaining till the honey is prepared for market in the following Autumn. The experience gained in that time would enable the beginner to start intelligently and avoid the mistakes one may readily fall into

without such experience. I offer this advice with a knowledge of the good results from taking cadets at the Government Apiaries.

If it is impossible to adopt this plan, then go cautiously to work at first, and don't lay out too much money. Three or four colonies your first season would be ample to work with, and to gain experience by. Some little increase the second season would be advisable, by the end of which sufficient knowledge of the work and your adaptation to it should have been gained to enable you to intelligently decide whether to increase your apiary or not. If you decide to go in on a large scale, then it is absolutely necessary for your own benefit that you choose a good district—a district where, in the first place, there is plenty of white clover—a dairying district—and not too difficult of access to a shipping port. Start with black or common bees, which probably may be obtained near at hand, but directly you decide to enlarge your apiary Italianise your colonies at once (see chapter on "Queen Rearing").

Don't stint your outlay for good bee literature, for the obtaining of one good "wrinkle" from the experience of a writer may be the means of adding largely to the profits of your apiary.

#### AXIOM.

"THE FORMATION OF NEW COLONIES SHOULD ORDINARILY BE CONFINED TO THE SEASON WHEN BEES ARE ACCUMULATING HONEY; AND IF THIS, OR ANY OTHER OPERATION, MUST BE PERFORMED WHEN FORAGE IS SCARCE, THE GREATEST PRECAUTIONS SHOULD BE USED TO PREVENT ROBBING,"

*Langstroth.*

## CHAPTER II.

### THE HONEY-BEE AND ITS VARIETIES.

THERE are many species of the genus *Apis*, or Bee, but only one which stores honey in such a manner as to be practically useful to man, and which Linnæus distinguished by the name *Apis mellifica*. The particular variety of this species known to Linnæus was the Black, or German bee. Since the beginning of the nineteenth century, other varieties were observed and described by Spinola and others, and were classed at first as distinct species. In the year 1862, Dr. A. Gerstaecker, of Berlin, first published the results of his investigations upon the "Geographical Distribution of the Honey-Bee and its Varieties," which is very interesting and of which I gave condensed extracts in my two previous editions, but as the interest of commercial bee-keepers is now chiefly centred in Italian bees, I shall only briefly describe the other varieties.

The black, or common bee, is inferior to the Italian as a honey gatherer, and as a defender of its hive from robbers and the large wax moth, and it is prone to act as a robber itself. Carniolans are good breeders, but greatly given to swarming, and as honey-gatherers, compared with Italians, I found them very poor. Syrians and "Holy Land" bees are much alike with regard to their qualities, which for profitable work are much below Italians. Cyprian bees are splendid workers, but outrageously vicious, so much so that after two years' trial I was compelled to smother a number of colonies, and it was simply impossible to handle them without being tortured by their stings. Smoke seemed to make them worse; therefore those who have any regard for their feelings had better not venture to keep Cyprian bees.

My Cyprians came direct from Cyprus, so that they were pure, and when I had them I was no novice at handling bees. Even worse in this respect was a cross strain between Cyprians and Italians that I raised; they would tackle the hot tin part of the smoker; but they were the best workers I ever had.

#### ITALIAN BEES.

Take them all in all, Italian bees are undoubtedly the best, and I affirm this after an experience with all the other varieties named, and a long acquaintance with the favourite bee. They are readily improved by judicious breeding, are good honey gatherers, excellent defenders of their hives from robbers and the wax moth, and can battle against disease better than the common bee. That it is the most profitable bee to cultivate is almost the universal opinion of advanced apiarists.

#### MARKINGS OF PURE ITALIANS.

It is well for the novice to be able to distinguish the difference between pure Italians and their crosses (Hybrids). Formerly, it was seldom that more than three yellow bands across the abdomen were seen on pure Italians, but of late years it has not been uncommon to see four and even five yellow bands. There should not, however, be less than three.

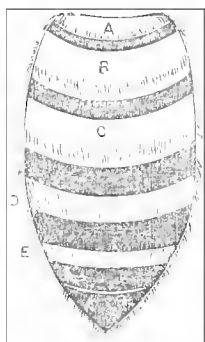

Fig. 1.—ABDOMEN OF ITALIAN WORKER BEE.

Referring to the illustration, A B C, Fig. 1, represent the three yellow semi-transparent bands; D E, and the shaded parts of A B C, are rows of greyish hairs. The three yellow bands should be plainly visible, though the band A, next the thorax, is sometimes very narrow, and may be overlooked at the first glance. The surest test of a pure colony, is that *all* the bees carry the three yellow bands.

There are light golden, and leather-coloured strains. Formerly it was considered that the latter were

the hardiest bees, but of late it is claimed that there are "Golden" bees equally hardy.

#### HYBRID BEES.

This is the name generally given to the cross between the Italian and black or common bees. Much has been said for and against hybrids, but from experience I feel satisfied that bees of the first cross between the blacks and Italians are in many cases equally as profitable as pure Italians. With regard to docility in handling, it is generally understood that hybrids are exceedingly vicious. While this may be true in some cases, I must say, after handling many thousands of hybrid colonies, that I have found very few indeed worse than some of the pure races I have had to do with. The worst bees I have noticed in this respect were nearly pure blacks, with a small dash of Italian blood in them. I advise, however, the cultivation of the pure variety.

#### AXIOM.

"BEES GORGED WITH HONEY NEVER VOLUNTEER AN  
ATTACK."  
*Langstroth.*

## CHAPTER III.

### INMATES OF THE HIVE—THEIR NATURAL HISTORY.

EVERY colony in a normal working condition, during the swarming season, will be found to contain bees of the three different kinds, the characteristics and relative sizes of which are shown in the illustrations which follow. First, one bee only of the peculiar form which denotes the queen or mother bee (one queen to a colony is the rule—see chapter on “Queen Rearing”); secondly, a number of large bees, called drones; and thirdly, many thousands of the smaller kind, called workers, which are the common bees to be seen on blossoms, as neither the queen bee nor the drones gather honey or work outside the hive.

The queen is indispensable to the prosperity of the colony. She is the only perfectly developed female, and lays all the eggs, of which she can, on occasions, produce two to three thousand in twenty-four hours. Without her the colony would soon dwindle down and die out, or be attacked and killed for the sake of its stores, as, after being deprived of their queen, the workers generally (unless they are in a position to rear a new one, as will be seen further on) lose the disposition to defend themselves and their home. The queen is not provided with the special organisation which enables the workers to gather honey and pollen and to secrete wax. She is furnished with a sting, which, however, she very rarely uses, except in a struggle with a rival queen. When she has been once impregnated, and has taken her place in a hive, she never leaves it except to accompany a swarm.\* Her

---

\* This has been disputed, but the claim that queens may leave the hive to be impregnated a second time has not been fully substantiated.

term of life may extend to three or even four breeding seasons, and during that time she may lay many scores of thousands of eggs; but she is considered to be in her prime in the second season, and is seldom very prolific after the third. She can be easily distinguished from the other bees, and be recognised even by the most inexperienced from the following description:—

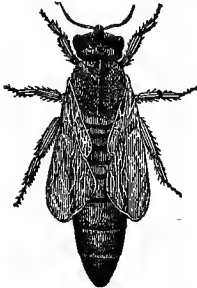

Fig. 2.  
THE QUEEN.



Fig. 3.  
THE DRONE.



Fig. 4.  
THE WORKER.

(Relative sizes, enlarged.)

Her body is not so bulky as that of a drone, though longer; it is considerably more tapering than that of either drone or worker; her wings are much shorter in proportion than those of the other bees; the under part of her body is of a lighter and the upper of a darker colour than the worker's; her movements are generally slow and matronly, and indeed she looks every inch a queen.

The drones, or male bees, are much stouter than either the queen or workers, although their bodies are not so long as that of the queen. They are neither furnished with a sting nor a suitable proboscis for gathering honey, no baskets on their legs for carrying pollen, and no pouches on their abdomens for secreting wax, so that they are physically incapable of doing the ordinary work of the hive. Their office is to impregnate the young queens, but very few have the chance of doing so; those that have, die immediately after-

wards, and the rest are usually destroyed by the workers at the end of the swarming season, having by this time become an incumbrance only.

The worker bees, the smallest in size, constitute the bulk of the population of the hive. A fair-sized swarm should contain at least from twenty to twenty-five thousand,\* and a well-stocked hive, during the full working season, will have twice, and sometimes nearly three times, that number of workers. They are all females, but not fully developed as regards their sexual organisation—they are incapable of being impregnated by the drones; but in some rare cases their ovaries are sufficiently developed to admit of their laying eggs, which, however, as will be shown later, are unfertilised, and produce only drones. On the other hand, these workers are specially provided with the means of successfully prosecuting their useful labours. They have a wonderfully constructed tongue, or proboscis, which enables them to suck or lap up the liquid sweet from the nectaries of blossoms, and to store it in a "honey sac," which is, in fact, a first or extra stomach, from which they can again disgorge it at will into the cells of their combs. Their hinder legs are provided with a hollow, or "basket," for carrying pollen, which they are enabled, by the use of their front legs and their proboscis, to work up into little pellets, and pack in these receptacles. They have the power of secreting wax in small scales under the folds of the abdominal rings of their body, and they are furnished with a sting to protect themselves and their stores, and of which they make effective use when provoked. They perform all the work both inside and outside the hive; collect the materials for honey, bread, and propolis; carry water, secrete the wax, build the combs, nurse and feed the young brood, ventilate the hive, and stand guard at the entrance when it is necessary to keep out intruders. Although

---

\* About 4,500 ordinary bees weigh one pound, so that a 5 lb. swarm contains about 22,500. Extra large swarms, however, sometimes weigh 7 lb. to 8 lb.



division of labour is beautifully exemplified in the economy of the hive, still there are not separate classes of worker bees (as was at one time supposed) to perform the different sorts of work; on the contrary, every worker bee is capable of doing all these things, and they take their turns accordingly. "One bee in her time plays many parts." The young bees are employed on "home duty" for the first week or two; they then take their turn of outdoor work, and are gradually worn out in the service. Their term of life is short, varying from only six or seven weeks in the busiest working season to several months after that busy time is past.

#### STRUCTURAL ORGANISATION.

Under this heading it is my intention briefly to touch upon two or three of the chief organs of the queen and worker bees, but for a fuller treatise on the anatomy and physiology of the honey-bee I must refer my readers to the third edition of this work.

#### HEAD OF WORKER BEE.

Within the small limits of a bee's head there are contained several important organs, some of them of a very complex nature. These are—the compound eyes; the simple eyes, or stemmata; the mouth and its appendages; and the antennæ. The engraving, Fig. 5, shows a front view (on a greatly magnified scale) of a worker bee's head.

The Compound Eyes are shown at b b, at right and left on top, and the simple eyes between them. Each compound eye is composed of something like 3,500 hexagonal convexities, or facets, which according to Cheshire are about one-thousandth of an inch in diameter, and are independent instruments of vision. The compound eyes are believed to be used chiefly for distant vision, and the simple eyes for objects near at hand.

The Antennæ (a) are wonderful structures under the

microscope. That they are organs of touch—"feelers"—there can be no doubt, and that they also perform the functions of hearing and smelling, although an open question at present, is generally believed by naturalists.

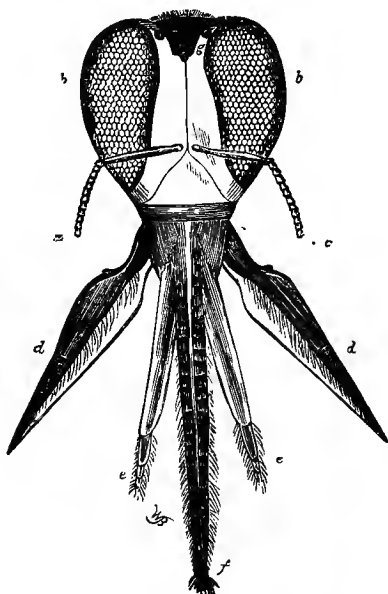

Fig. 5.—HEAD OF WORKER BEE.

*a*, Antennæ; *b*, Compound eyes; *c*, Jaws; *d*, Maxillæ; *e*, Lateral palpi; *f*, Ligula, or tongue; *g*, Stemmata.

The Mouth Parts consist of several organs, as shown in the figure, the chief of which is the tongue. The end of this is covered with whorls of hair, and is furnished with a spoon-shaped hollow on the under side, opening into a capillary tube on the upper side, into which the liquid passes when the bee is sipping. Herman Müller, in his work on "The Fertilisation of

Flowers," beautifully describes the process of gathering nectar. He says:—

"When the bee is sucking honey which is only just within her reach, all the movable joints of its suction apparatus, cardines, the chitinous retractors at the base of the mentum, laminae (maxillae), labial palpi, and tongue, are fully extended, except that the two proximal joints of the labial palpi are closely applied to the tongue below, and the laminae to the mentum and hinder part of the tongue above. But as soon as the whorls of hair at the point of the tongue are wet with honey, the bees, by rotating the retractors, draw back the mentum, and with it the tongue, so far that the laminae now reach as far forward as the labial palpi; and now labial palpi and laminae together, lying close upon the tongue, and overlapping at their sides, form a tube, out of which only a part of the tongue protrudes. But almost simultaneously with these movements, the bee draws back the basal part of its tongue into the hollow end of the mentum, and so draws the tip of the tongue, moist with honey, into the tube, where the honey is sucked in by an enlargement of the foregut, known as the sucking stomach, whose action is signified externally by a swelling of the abdomen."

#### REPRODUCTIVE ORGANS OF THE QUEEN.

The most important organs of the queen bee—themselves forming perhaps one of the most wonderful objects of nature, and of which the very accurate knowledge which we now possess, owing to the patient researches of many naturalists, has done more than aught else for the progress of scientific bee-culture—are her ovaries and the parts attached thereto, which are illustrated in the following engraving (Fig. 6).

The two fig-shaped bodies are the ovaries, which are multi-tubular, there being more than a hundred tubes (called the ovigian tubes) in the two ovaries of a queen bee. In these tubes the eggs grow and develop until they are fit to be deposited. Each ovary has a separate oviduct at bottom, through which the eggs pass for some distance, until the two join in one common oviduct leading to the vulva, or vent, through which the eggs are ultimately deposited. A little below the junction of the passages from the two

ovaries, and on the outside of the common oviduct, is a small globular body, shown on the right hand side in the engraving. This is a hollow vessel, called the spermatheca, of which much has to be said. More

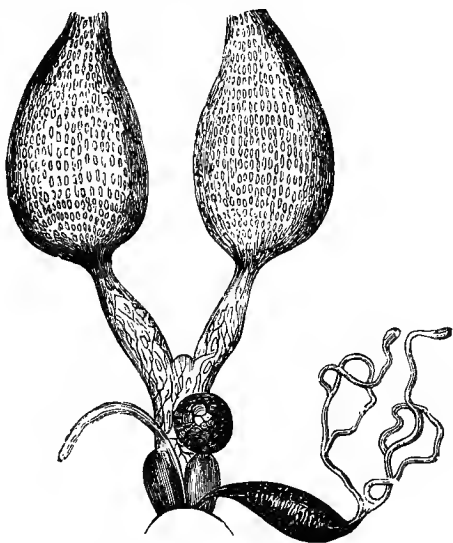

Fig. 6.—OVARIES OF QUEEN.

than two hundred years ago Swammerdam published an excellent illustration of the ovaries of a queen bee, showing the spermatheca, but he conjectured that it secreted a fluid for sticking the eggs to the bottom of the cells in the comb. In his time but little was known of what went on within the hive. It was no doubt assumed by many that every single egg laid by the queen required to be fertilised by a separate act of the drone, while Swammerdam himself conceived the idea that no copulation was necessary, but that some gaseous emanations from the body of the drone produced fecundation by penetrating the body of the queen. About a hundred years later great advances

were made in the knowledge of the physiology of the bee. It is said that Janscha, apiarist to the Empress Maria Theresa of Austria, discovered the fact that young queens have to leave the hive to meet the drones; but it is to the labours of Huber, in 1787 and following years, and communicated in his letters addressed to Bonnet in the years 1789 to 1791, that we owe the first knowledge of the following main facts:—1. That the queen bee is truly oviparous; that what she deposits is a true egg, which takes three days to produce a living maggot or larva—(even the great Bonnet was inclined up to that time to believe that a minute worm, and not an egg, was produced by the queen). 2. That the queen must be impregnated by the drone in order to become fertile. 3. That copulation is accomplished outside the hive and while on the wing high in the air. 4. That one impregnation was sufficient to fertilise all the eggs laid by the queen subsequently for two years at least, perhaps for life. 5. But that if the act of impregnation was delayed beyond the twenty-first day of the queen's life, her eggs would afterwards produce only drones. Huber also proved that queens could be reared from the larvæ of worker eggs, and also that in some rare cases workers were able to lay eggs, which, however, could only produce drones. He investigated other matters of the greatest importance to the science of bee-culture, and was gratefully designated The Prince of Apiculturists by Langstroth. He failed, however, to discover the secrets of the spermatheca, and remained under the false impression that the fertilisation of the eggs took place in the ovaries and that there were two kinds of eggs, one sort to produce workers and queens, the other to produce drones, and that they occupied separate portions of the ovaries. His contemporary, Schirach, who also contributed much to apiarian science, supposed that one branch of the ovaries contained the one kind and the second branch the other kind of fertilised eggs. In this state the science remained for some sixty years. Langstroth said it is now ascertained that Posel, in a work published at

Munich in 1784—therefore previous to the experiments of Huber—“describes the spermatheca and its contents and the use of the latter in impregnating the passing egg”; and also that “years ago the celebrated surgeon John Hunter and others supposed that there must be a permanent receptacle for the male sperm opening into the oviduct.” Nothing certain was known, however, until 1845, when the brilliant discoveries of Dzierzon led to the promulgation of the theory which bears his name, and especially to the doctrine of

#### PARTHENOGENESIS.

On this point Professor Cook says:—

“This strange anomaly—development of the eggs without impregnation—was discovered and proved by Dzierzon in 1845. Dr. Dzierzon, who as a student of practical and scientific apiculture must rank with the great Huber, was a Roman Catholic priest of Carlsmarkt, Germany. This doctrine—called Parthenogenesis, which means produced from a virgin—is still doubted by some quite able bee-keepers, though the proofs are irrefragable.”

Space will not admit of going into the details of observations and experiments by which the case has been proved, but they are fully discussed in an excellent little work on the Dzierzon Theory by the Baron von Berlepsch.

#### DEVELOPMENT FROM THE EGG TO THE BEE.

Having now come to understand the manner in which the egg, whether male or female, is laid, we may examine the egg itself, and the way in which the germ it contains becomes developed into the full-grown insect.

The egg, when laid in the cell, requires a tolerably sharp sight to distinguish it as it lies at the bottom, attached by one end to the comb by means of some glutinous fluid with which it is coated. It is very small and not round or oval like a bird's egg, but long, like a small worm or maggot. It is, however, a true egg.

It appears covered with a sort of delicate network, which is, in fact, its shell, and it has a yolk and surrounding white, or albumen, like all eggs of birds or reptiles. When deposited in a worker cell, it remains unchanged in outward appearance for three days, when the larva first appears as a minute worm, and goes through the stages of development shown in the following figure; the numbers underneath denoting the age, in days, from the laying of the egg.

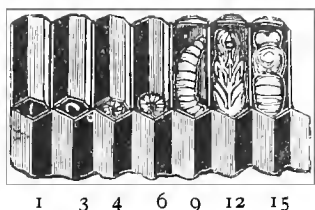

Fig. 7.—FROM THE EGG TO THE BEE.

The larva, when it emerges from the egg, is fed by the workers, which act as nurses, with a mixture of bee-bread, honey and water, the two first-mentioned materials having undergone a partial digestion in the stomach of the bees, and been converted into a species of chyle. Whether the water is mixed with the food so prepared, or is required for the process of digestion to prepare it, certain it is that during the breeding time great numbers of bees are to be seen imbibing water, and bringing it to the hive. This process of feeding the larvæ continues five days for the workers and six and a half days for the drones, and the cells are then capped with a mixture of wax and pollen, which forms a safe covering for the cells, but is sufficiently porous to admit the air necessary for the life of the larva and pupa, or nymph, during its period of metamorphosis. As soon as the cell is closed, the grub begins to spin a web or cocoon round itself; this spinning goes on for thirty-six hours, when the cocoon is complete, and then ensues a period of rest, or apparent rest, and subse-

quent metamorphosis, during which time a wonderful transformation is going on from hour to hour. This includes the pupa or nymph period, and lasts altogether thirteen days for workers and fourteen and a half for drones; and at length, on the twenty-second day from the laying of the egg in the former, or on the twenty-fifth day in the latter case, the fully formed bee cuts through the capping of the cell with its mandibles, and emerges complete in every respect, and ready, *without any previous training, education or experience*, to fulfil its functions, to execute all the delicate operations, and to observe those rules of conduct which appear to us (and justly) to be such marvels of intelligence, ingenuity, dexterity and even foresight.

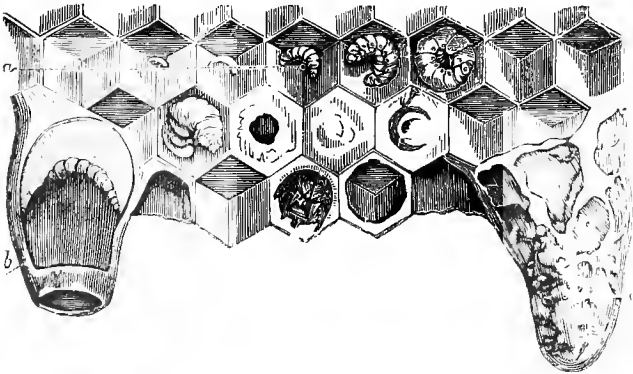

Fig. 8.—WORKER EGG LARVAE AND QUEEN CELLS.

The cells in which queen, or perfect female eggs are laid and developed differ widely from those of the workers and drones; in the natural state, they are only built in the swarming season, or in cases where the colony has become queenless; in the former case the cells are laid out for the purpose on the under side, in a depression, or on the edges of the comb, as shown in Fig. 8, which exhibits, on an enlarged scale, the top



view of a number of worker cells, with the egg and larva in the different stages of development up to the time of capping the cells (in the line marked A); a section of a queen cell (B) showing the larva and a supply of the royal jelly, and a similar one completed and closed (at C). They somewhat resemble a peanut in shape.

The material of which these cells are composed is not pure wax; there is much pollen mixed with it. The outside surface is uneven and indented like the sides of a thimble. The number built at one time varies much, according to circumstances—sometimes only two or three, but ordinarily not less than five or more.

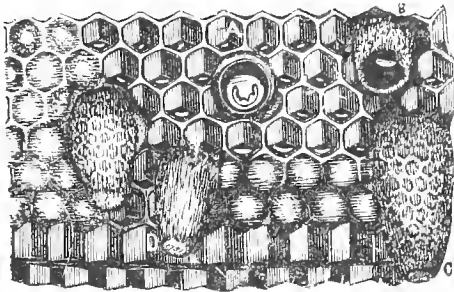

Fig. 9.—QUEEN CELLS BUILT OVER WORKER CELLS.

The transformations of the queen larva are completed in seven days from the closing of the cell, so that on the sixteenth day from the laying of the egg (six days shorter than the period for the worker, and nine days shorter than that for the drone) the fully developed queen emerges from the cell.

In the case of a colony becoming queenless in an abnormal manner, queen cells may be built over worker eggs or larvæ in convenient places on the flat surface of a comb as shown in Fig. 9. The ordinary worker cells, with eggs in them, are shown at A; B is a queen

cell partly built; and c one completed and closed. D shows a case, which sometimes occurs, of a queen cell built over drone brood. Such cells—which may be known by the absence of indentations on their outer surfaces—are of course useless, as the nature of the drone egg is not altered by the form of the cell or the quality of the food given to the larva.

#### THE STING.

The sting of the worker bee is a very complicated organ, as will be seen by a study of the following engraving, taken from Root's "A B C and X Y Z of Bee-Culture."

In the general view of the sting (i) is the double gland in which the poison is collected from the glands, and which secretes the poison; A, the cylindrical reservoir from which it is transmitted through hollows in the spears or lancets to the wound; B, the two barbed lancets; and D, the third spear or awl, usually styled the sheath, in which the other two partly slide when at work. In the cross section (greatly enlarged) of the lancets, at the point D, it will be seen how the two hollow lancets, A and B, slide on ribs or guides in the concave side of the so-called sheath, D. They have tubes, F and G, through which, as well as through the tube E, formed between the three parts of the sting, the poisonous fluid is transmitted. There is a hollow, C, in the awl or sheath, D, but it is only for strength and lightness, and is not open either above or below. In the barbed lancets, the end of one of which is shown, greatly magnified, there are grooves, G, to fit on the ribs of the sheath, and the poison, which is conveyed down the hollow tube inside of each, finds vent by small side openings to the barbs at H H. It appears that when the wound is first pierced by the smooth and highly polished point of the awl, D, a sliding motion is communicated to the barbed lancets by the muscles shown at J and K, and the poison is *pumped* into the wound through the centre cavity, E; the barbed lancets are then driven in by alternate motions, and at the

same time the centre cavity is closed by valves at the root of the sting, and the poison is forced through the tubes in the hollow lancets, and through the side openings near the barbs. The barbs having once

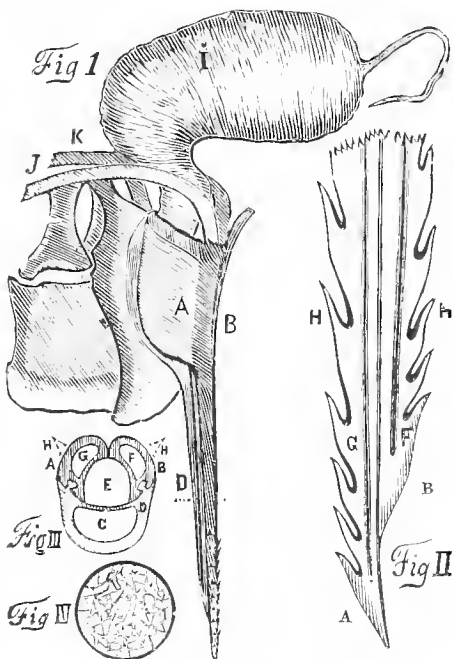

Fig. 10.—THE BEE STING.

- i.* Bee sting, magnified.
- ii.* One of the barbed lancets.
- iii.* Cross section of lancets at D.
- iv.* Drop of the poison, crystallised.

penetrated any tough material, such as the human skin, cannot be withdrawn by a direct pull. The bee, if left to itself, will gradually work round and round

in its endeavour to withdraw the sting, but if it be abruptly shaken or brushed off, the whole sting is torn out of its body and left behind. In that case the muscles will continue to work and to force poison into the wound for some time, if the sting be not carefully extracted, which should be done without squeezing the poison reservoirs at its base. The injury occasioned to a bee by the tearing out of its sting must be very severe, and it has been generally supposed that they die immediately afterwards. Sir John Lubbock (Lord Avebury), however, in his work on "Ants, Bees, and Wasps," says: "Though bees that have stung and lost their sting always perish, they do not die immediately, and in the meantime they show little sign of suffering from the terrible injury." He mentions having seen a bee after losing its sting, remain twenty minutes on the floor-board, enter the hive, return in an hour, feed quietly on some honey, and again return to the hive.

It is said:—"1. The poison of the hymenoptera is always acid. 2. It is composed of a mixture of two liquids, one strongly acid, the other feebly alkaline, and acts only when both liquids are present. 3. These are produced by two special glands that may be called the acid gland and the alkaline gland. 4. These two glands both expel their contents at the base of the throat from which the sting darts out."

#### LAYING OR "FERTILE" WORKERS.

The existence of egg-laying workers in a hive upon certain rare occasions was noted by J. Riem even before Huber's time, and fully confirmed by the latter. They are, of course, quite useless for keeping up the stock of a hive, as their eggs can only produce drones. They generally make their appearance after a colony becomes queenless and minus of the wherewithal to raise a queen.

The presence of a fertile worker may be known by its eggs being scattered about promiscuously, sometimes on the sides and edges of the cells, and generally

more than one in each. I have seen as many as a dozen in one cell. To get rid of them is sometimes a difficult matter, for unless they were seen in the act of laying one would not know them from the other workers; and usually the colony will not accept a queen or queen cell when in this condition. If the hive has become weak it will be best to unite it with another; and I believe in any case this is best, for I have tried other means to get rid of them, but without success. A sharp look-out should be kept to prevent a colony getting into this condition, but it will happen sometimes in spite of all our carefulness, as I have found.

#### AXIOM.

“BEES, WHEN FRIGHTENED BY SMOKE, OR BY DRUMMING ON THEIR HIVES, FILL THEMSELVES WITH HONEY, AND LOSE ALL DISPOSITION TO STING, UNLESS THEY ARE HURT.”

*Langstroth.*

## CHAPTER IV.

### WHAT BEES COLLECT, AND WHAT THEY PRODUCE.

BEES *collect* three different sorts of raw materials, all of vegetable origin: (1) the sweet liquids secreted by plants in the nectaries of their blossoms, or exuded on parts of their leafy structure; (2) the pollen, or fecundating dust of plants; (3) resinous matter exuded on various parts of some trees and plants. They *produce*, on the other hand, honey, wax, bee-bread, and propolis. This distinction must be borne in mind if we wish to be precise both in our ideas and our mode of expression.

#### HONEY.

The raw material of the honey is entirely a vegetable production; it is excreted or thrown off by the plant, from the superfluity of its saccharine juices, which, when subjected to chemical analysis, are found to consist of nearly the same constituents as all sugars, starch, gum, and other non-nitrogenous vegetable secretions, namely, of carbon, oxygen, and hydrogen, the two latter in the proportions required to form water. This nectar, therefore, does not contain any of the nitrogenous or of the mineral substances furnished by the soil, and which require to be returned to it, in some degree at least, by the use of manures. Liebig and other chemists have proved that all the elements of the non-nitrogenous vegetable substances are derived from the atmosphere and from rain-water; it is clear, therefore, that no quantity of honey produced in any district can tend to impoverish the soil from which the nectar is collected.\*

---

\* This matter was fully dealt with in the third edition of this Manual, and also in Bulletin No. 18 on Bee Culture, issued by the New Zealand Department of Agriculture, third edition, March, 1909.

While lying in the nectaries of blossoms, and being collected by the bee, or afterwards when being stored in the honey-comb, it may by accident take up some particles of pollen, which will account for the fact that minute grains of that substance are generally discoverable in honey when examined with the microscope. In its passage through the honey-sac of the bee, and in the act of being stored in the cells of the comb, the raw juice goes through a process of ripening, which deprives it of much of its superfluous watery particles (see Chapter XIII.), and while in the honey-sac it is also probably in some way chemically affected by the juices from the salivary glands of the bee.

When, by evaporation, the proportion of moisture is reduced to a certain extent, and the honey becomes what we term "ripe," it is sealed in the cells by the worker bees, just as the preserves of a careful house-keeper are closed up so as to save them from the action of the oxygen in the atmosphere. The honey in this ripened state is nearly the same, in point of chemical composition, as ordinary sugar; but it owes its perfume and flavour apparently to the same volatile oils which attracted the insects to the flowers from which it is derived, and that it is indeed something very different from common sugar is sufficiently clear to everyone.

#### HONEY DEW.

There is a saccharine matter sometimes gathered in considerable quantities by bees in countries of the Northern Hemisphere termed "honey dew." It is quite distinct from, and much inferior to, ordinary honey. Considerable difference of opinion has at various times been expressed as to its origin, some holding that it is entirely a vegetable product, while others claim that the larger proportion is an excretion from certain insects. Dr. E. F. Phillips, who has had special opportunities for studying the matter, says:—

"Honey dew is a general term, including sweet substances from several sources. There are many plants which have nectaries outside the flower which secrete honey dew

which is gathered by bees. Among these may be mentioned hau (*Paritium liliacum*), of Hawaii, cotton, some of the acacias, and conifers. It is a mistake, however, to assume that this is characteristic of the majority of plants from which honey dew is gathered, for the greater part of honey dew is not a plant secretion, but an insect product."

The United States Government has formulated an official standard for honey, and any product not coming up to the test, whether gathered and stored by bees, or not, must not be sold as honey. Honey dew is below the standard. Though large quantities are sometimes gathered in the United States and other countries, I have never heard of bee-keepers in this part of the world being troubled with it. If they had, it could hardly have escaped my knowledge.

#### ADULTERATION OF HONEY.

Formerly there were large quantities of adulterated honey foisted upon the markets of the world by certain American houses, very largely composed of glucose. It was carried out upon such a gigantic scale that "American Honey" (?) became a by-word for fraud, and an immense amount of harm was done to the bee-keeping industry in that country. Thanks, however, to their pure food laws, and the strictness with which they are now enforced, I believe that there is little, if any, of the fraudulent practice carried on there at present. Consumers of honey in Australasia who patronise the locally raised honey need have little fear of getting anything but the pure article, especially if it is sold under a reputable brand.

#### BEE SWAX.

Until Huber's time it was generally believed that wax was gathered from certain flowers by the bees in the same way as honey is procured, but there must be very few people in the more enlightened nations who do not now know that it is secreted by the bees, so that there is no need to take up space to explain how this was proved.



It has been pointed out that, while honey and sugar contain by weight about eight pounds of oxygen to one of carbon and hydrogen, beeswax contains only one pound of the first to more than sixteen of the two latter; and that, as the combustion of oxygen is the great source of animal heat, the large quantity consumed in the conversion of honey into wax "must aid

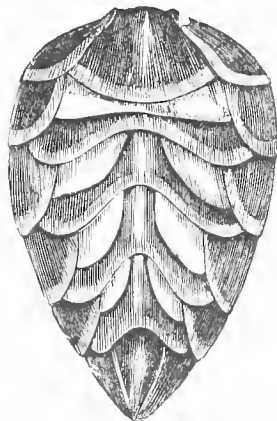

Fig. 11.—UNDER SIDE OF ABDOMEN OF WORKER BEE,  
SHOWING WAX POCKETS AND WAX SCALES.

in generating the extraordinary heat which enables the bees to mould the softened wax into such exquisitely delicate and beautiful forms." The force of this observation will be seen when we recollect that wax requires a temperature of about  $145^{\circ}$  to melt it, though it may be moulded, by pressure, at  $100^{\circ}$  or less. Is it not probable that the way, in which it has been said that "bee-bread assists the bee in producing the wax," as Langstroth expresses it, is that its nitrogenous qualities serve to keep up the bodily strength of the insect during the exhausting work of secreting the wax and building the comb? This appears to be Professor Cook's view. At all events, it is now well known that

the wax is exuded from the body of the worker bee, and formed in thin flakes in what are termed the wax pockets, of which four may be observed in the foregoing engraving, on each side of the centre line on the under-part of the abdomen, and which are, in fact, the folds of the shell-like plates covering the abdominal rings.

The wax can only be secreted when the temperature of the hive is above a certain point, and during the time of secretion the bees appear to hang in clusters or festoons, in a state of absolute repose. In the height of the honey season, or so long as new comb is required, this secretion goes on night and day. Langstroth says that "careful experiments prove that from thirteen to twenty pounds of honey are required to make a single pound of wax." This was for a long time accepted as a well-ascertained fact; but within the last few years some American and English apiarists have begun to doubt if quite so much honey is consumed, and lately it has been stated, on the strength of some isolated experiments, that the bees do not consume more than eight pounds of honey in order to secrete one pound of wax. Many more careful experiments will be requisite before this can be satisfactorily proved or disproved. In the meantime it may be asserted that something between eight and twenty pounds are required, but the exact quantity is still an open question—the consensus of opinion points to twelve pounds.

#### ADULTERATED BEESWAX, AND HOW TO DETECT IT.

With the growing scarcity of beeswax during the past twenty years and the consequent increase in price, came the opportunity for the adulterator. At first the adulteration was carried on in a very clumsy style and easily detected, tallow and resin being chiefly used. But of late years the fraudulent imitation of the pure article has been so cleverly made that except by experts or by direct tests it could not be detected.

The usual adulterants nowadays, and which are so

difficult to detect by the uninitiated, are the ordinary commercial paraffins and ceresins, and for these the simplest way of detecting them is by the alcohol test. Too much reliance, however, must not be placed in it as it is quite possible that something else might be added to make the test unreliable.

Into a clear glass bottle pour a little clean water, then drop in a small piece of beeswax of known purity; the wax being lighter than the water, will float. Now pour in gradually pure alcohol till the wax slowly sinks to and touches the bottom, but no more. Then drop in a piece of the suspected article: if it does not sink slowly like the wax there will be every reason for believing it to be adulterated. When there is more than 5 per cent. of either of the two adulterants present the stuff will float, while the pure beeswax lies at the bottom of the liquid.

#### WILL IT PAY TO RAISE BEESWAX?

I am certainly inclined to believe that at the present price of beeswax, and with every prospect of its getting dearer, it will pay to raise it instead of honey, where the latter is of a low grade, such as in some bush districts. I know of bee-keepers living near bush that would like to extend their operations, but owing to the difficulties of getting their honey into shape for market, and the low price received for it, prevents them from doing so. To such people the raising of wax might prove of enormous benefit. It occurs to me that some inexpensive form of large home-made hive, carrying fifteen or sixteen frames, of say, twelve or fourteen inches deep, which could also be made on the spot, might be used. Small fillets of wood dipped in wax tacked along the centre of the underside of the top bars would induce the bees to build straight combs within the frames in the first place, after which there would be no trouble, as a small strip of comb could be left in each time they were cut out. Most of the combs could be removed as they were built, and in this way the bees would be kept chiefly at comb building

through the season, and the greater part of the honey gathered would be converted into wax, leaving sufficient of both comb and honey to see them through the winter.

I think it quite likely that if worked in this way each colony started early in the season should yield from four to five lbs. or more of clean marketable wax, which at present prices, from  $1/3$  to  $1/6$  per lb., would pay far better than raising low grade honey. I offer the above as a suggestion worth considering. It was one of the experiments I intended carrying out at the Waerenga State Apiary, where a low grade honey is frequently gathered, had I continued as Government Apiarist.

#### RENDERING COMBS INTO COMMERCIAL WAX.

Of all the operations in connection with apiary work, I think the rendering and cleaning of small quantities

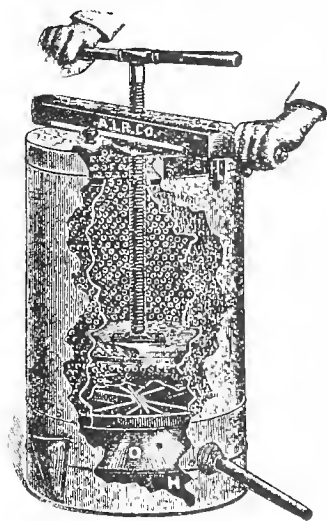

Fig. 12.—GERMAN STEAM WAX PRESS.

of comb to convert it into commercial wax, has hitherto been the most unsatisfactory. Through the want of some simple, inexpensive, but efficient method, a large quantity of comb in the aggregate is wasted annually, as it does not pay to bother with small lots. Hot water and pressure, steam and pressure, and sun-heat, are the three methods employed. In apiaries of 40 colonies or more it pays to get the best appliance in use for this work, as the gain in the wax saved will soon defray the cost, and give an annual profit.

WAX PRESSES.

The wax-press as shown in Fig. 12, usually known as the "Root-German Wax and Honey Press," is a very popular one, and is largely in use also as an uncapping can. H is the boiler, which should be two-thirds filled with water, and then the can set on a fire after removing the screw and the perforated can from inside. A scrim bag about ten inches deep, and three-fourths the diameter of the can, should be nearly filled with comb, well pressed in, and the top of the bag folded over, this is placed in the can. By providing an extra follower or two of boards, two, or even three, such bags of comb may be pressed at one time—a follower over each bag. The steam from the boiler H will ascend around the false bottom G through the comb, and no pressure must be put on until the wax ceases running from the spout. After pressing, loosen the screw and take it out while the bags are shaken up, then put in the screw again—and repeat the process until no more wax can be got.

I have had quite a number of favourable reports of the "Hatch" Press, Fig. 13. In fact.

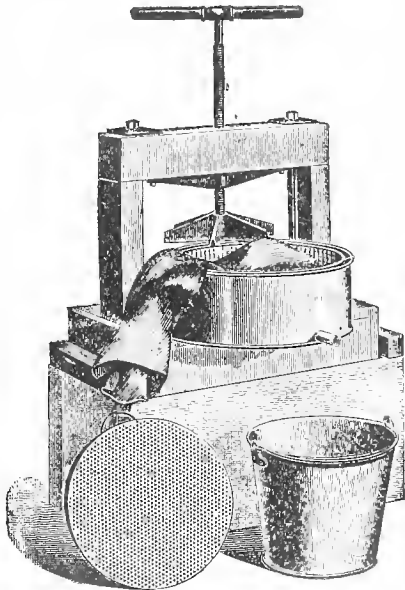

Fig. 13.—"HATCH" WAX PRESS.

it appears to be the one most favoured at present. It differs from the German Steam Press, in that the comb is first heated in a boiler with water which is kept over a good fire. Paperhanger's scrim is laid in the press basket, about one gallon at the time of the melted combs and hot water is dipped from the boiler and put into the scrim, the follower is placed on top, and the whole screwed down. The wax and water runs from the spout shown, into a tin or bucket placed to receive them; the cake of wax floats on top when cool.

Iron boilers should never be used for melting or cleaning wax with hot water, as the iron and water combined turns the wax a dull dark colour; copper is best.

#### THE SOLAR WAX EXTRACTOR.

My first experience with the Solar Wax Extractor, some twenty-three years ago, and after, gave me a very poor impression of them, and in the last edition of this Manual I condemned them. Further experience, however, with an improved pattern to those I first used has entirely altered my opinion, and I can now speak of them in the highest terms. My first extractors were too deep as I afterwards discovered, the heat, or a good part of it, was no doubt wasted instead of being concentrated on the combs.

In 1906 I had one constructed on the "Boardman" pattern, Fig. 14, which worked splendidly. It was at work at the International Exhibition Apiary at Christchurch, New Zealand. It stood in the open without any special shelter, and the inside temperature, as tested frequently, went over  $220^{\circ}$  Fahr., and on one occasion I found it reached  $231\frac{1}{2}^{\circ}$  Fahr., or  $19\frac{1}{2}^{\circ}$  above boiling point. The refuse from old combs came out of the extractor quite dry without a particle of wax in it, while the wax was of a nice bright colour. I had two others made for the Government Apiaries, and they have given every satisfaction.

The following are the particulars of their construction:—The dimensions outside are—length, 5 ft. 3 in.;

width, 2 ft. 8 in. ; depth of main part of body,  $4\frac{1}{2}$  in. ; wax-receptacle at lower end of body, 9 in. wide by 8 in. deep. The sash is furnished with two sheets of glass with an air-space of 1 in. between them. The wheel on which the extractor is mounted is 4 ft. 6 in. diameter, and works on an axle about 2 ft. long, driven into a



Fig. 14.—SOLAR WAX EXTRACTOR.

block of wood in the ground. The body of the wax-extractor is lined with black sheet iron turned up at the sides, and fitting loosely in the extractor. A long tin divided into three compartments fits in the lower part for catching the wax as it runs from the combs. The tin and the divisions should run smaller at bottom than at the top, to facilitate turning out the cakes of wax, and the tops of the two divisions should be  $\frac{3}{4}$  in. below the top of the tin. The middle compartment will

then retain any dirt or foreign matter running in with the wax, while the clean wax will flow over into the outside compartments.

The woodwork of the Extractor must be substantial and well put together to stand the great heat, and it is well to have the edge of the sash bound with  $1\frac{1}{2}$  inch angle iron. The depth inside from the lower sheet of glass to the iron lining should not exceed from  $2\frac{1}{2}$  to 3 inches.

If in a warm corner of the apiary and well sheltered, the Extractor will work at almost all times when the sun is shining. Such an appliance will soon pay for itself in a fair-sized apiary, for every particle of comb can be put in at once and converted into good commercial beeswax. instead of being wasted. Mounting the Extractor on a wheel is for convenience of turning it to the sun.

#### SULPHURIC ACID FOR CLEANSING DIRTY WAX.

Opinions differ as to whether it is advisable or not to use sulphuric acid in cleansing wax; the A. I. Root Company use it and recommend its use. On the other hand, C. Dadant says "Don't use any acids as it takes the smell of the bees out of the wax." The two firms are the largest makers of comb-foundation in the world, so should be good authorities—it seems to be a case of "When doctors differ, etc." The Root Company say there is no satisfactory way of cleansing dirty wax than by treating it with acid.

A suitable boiler half filled with water is placed over a fire; when the water boils put in the cakes of dirty wax. When all is melted, add the sulphuric acid, then let the fire gradually die down. When the dirt has time to settle the clean wax may be dipped off the top, taking care not to disturb the dirty water underneath. The proportion of acid to use is a half pint to 125 lbs. of wax.

Doolittle recommends one pint of strong vinegar in one quart of water to each 10 lbs of wax—the acid is far cheaper.



## HONEY AND BROOD COMBS.

Wax, after being produced by the bees, is formed by the workers into comb, which consists of hexagonal-shaped cells of two sizes—one for the deposit by the queen of the worker eggs, the other for the same purpose, for drone eggs; and these are known by the names of "worker" and "drone" comb.—Fig. 15.

The worker cells measure about five to the lineal inch and the drone cells about four. When used for breeding purposes the former are slightly under half an inch in depth, and the latter five-eighths of an inch, but when used for the storage of honey they vary in depth according to the space available.

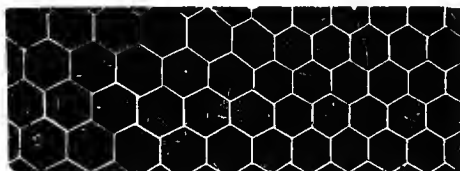

Fig. 15.—DRONE CELLS.—WORKER CELLS.  
(Natural Size.)

The bees when allowed to construct their own combs entirely, usually build much drone comb, which is subsequently utilised for breeding what appears to be an unnecessary number of drones, but the use of worker comb-foundation entirely obviates this evil.—See chapter on "Comb-Foundation."

## POLLEN AND BEE-BREAD.

Pollen is the dust-like particles of farinaceous matter which constitutes the fecundating principle of the stamens of flowers and blossoms of all kinds. The manner in which it is collected by bees has been already described in Chapter III. It is of great importance in the economy of the hive, as, after being mixed with a little honey, and packed in the cells of the brood combs,

it forms the bee-bread, which is indispensable to the nourishment of the young bees, and without which, as has been proved, no brood can be raised. It is very rich in nitrogenous substances, which are necessary for the formation and maintenance of muscular tissue, and therefore to the development of the young bees.

The grains of pollen, although so minute as to form an almost impalpable dust, exhibit when viewed through a powerful microscope very beautiful and distinctive markings, according to the plants from which they are obtained. Previous to Huber's experiments, bee-bread was supposed to be used in comb-building. He, however, proved, as we have seen, that comb could be built by the bees in confinement, by being fed with honey or sugar syrup alone. He was not long in discovering that pollen was used for the nourishment of the young bees. Confining some bees to their hives without pollen, he supplied them with larvæ, honey, and eggs. In a short time the young all died. A fresh supply of brood being given them, with plenty of pollen, the development of the larvæ proceeded in the natural way.

#### PROPOLIS.

This is a substance used by the bees for glueing things together, and for stopping up all crevices in their hives. In order to make it they gather the resinous matter which exudes from some trees; or when this is scarce they will take varnish, or even tar. They carry this substance home in their pollen baskets, and use it, mixed with wax, wherever they want to fasten any loose parts, or to fill up joints to exclude enemies or air. They make a very liberal use of it at the end of the honey season. It is a great nuisance in some districts.

#### AXIOM.

“THE BEE-KEEPER WILL ORDINARILY DERIVE ALL HIS PROFITS FROM STOCKS STRONG AND HEALTHY IN EARLY SPRING.”

*Langstroth.*

## CHAPTER V.

### THE APIARY.

#### LOCATION.

TAKING into consideration the climate, the flora, both indigenous and exotic, and the results which have heretofore followed the introduction of bee culture in all parts of Australasia, I feel safe in saying that there is no part of it which is at all fitted for European settlement where the culture of bees may not be carried on to a greater or less extent with advantage, but it does not therefore follow that every district is adapted for the working of extensive apiaries. No person should attempt the establishment of a large apiary without first making himself acquainted with the resources of the neighbourhood, and to do this effectually he must first have a knowledge of the flora which is best suited to his purpose. Clover honey being in greatest demand and the most profitable to raise, it is wise to select a district where plenty of white clover is grown, a dairying district for instance. Sheep farming or cropping districts are not desirable. New Zealand offers large stretches of clover country to choose from, extending almost the length of the two islands. In the chapter on "Bee Forage" I have dealt with the best of the Native flora of Australia and New Zealand.

The instructions which follow are based on the supposition that a fair sized apiary of from seventy-five to a hundred colonies will be sooner or later established.

#### SHELTER.

Next to selecting a good locality, arranging for good shelter is the most important matter. The conforma-

tion of the ground may afford some convenience in this respect. When there is a choice, select a low-lying spot so long as the drainage is good and the ground dry, so that the bees when flying home laden will have easier work. Such a situation can be more readily sheltered. When shelter must be grown, select plants that make a durable hedge, and that will bear cutting back well, so that it can be kept, say, about eight feet high. This is high enough to shelter a large apiary, and not too high to take swarms from. Giant privet (*Ligustrum sinense*) is the best plant I know for the purpose, and can be thoroughly recommended. When planted in two rows three feet apart and eighteen inches apart in the rows, and the soil about them kept stirred now and again, and clear of weeds for a couple of seasons, a real good shelter fence may be obtained in about four seasons. A temporary shelter fence may be erected in the meantime of brushwood while the other is growing.

Tagasaste (*Cytisus proliferous*) grows very rapidly, and will form decent shelter in two seasons, but in the Auckland district it does not last more than from four to five years when cut back. It is a good plant to grow, as it affords excellent bee forage in winter and early spring. The seeds are sown where the plants are to grow, as they do not transplant well. The seeds require steeping in hot water before sowing, and should be sown immediately after, three feet apart. Do not plant tall growing trees near the apiary to give swarms an opportunity of settling out of reach. Both the above hedges should be protected from cattle of all kinds.

#### WATER.

Good clean water near the apiary, easily accessible to the bees, is a great boon where there are many colonies. A great deal of water is required right through the breeding season. A clear, running, shallow stream affords the best watering place, but in the absence of a natural supply, water should be provided in shallow water-tight troughs filled with pebbles, placed under shade near at hand, taking care to keep

them supplied with water, and that they are cleaned out frequently. Bees often become a nuisance by congregating around cattle troughs and domestic supplies, hence the reason for having water in or close to the apiary.

#### ARRANGEMENT OF THE APIARY.

In the first place, the hives should stand out in the open clear of all trees, tall hedges, fences, and buildings. If the hives are properly constructed, as explained in the next chapter, and painted a light colour, they should stand on the ground, and will not need any kind of



Fig. 16—GOVERNMENT APIARY.

shade. It is a mistake even to put them among fruit trees; they should be clear of everything that will tend to impede rapid work. Hives are sometimes placed under ever-green trees, in dense shade, when, after a time, the occupants become exceedingly vicious, and are difficult to handle. Such hives are likely to become damp inside in winter, and the-combs mouldy.

I have no hesitation whatever in saying that the best and most convenient arrangement of hives in an apiary is singly, and in straight rows. Some bee-keepers, but

comparatively few, place them in clumps of two or more. I can see no advantage, but several disadvantages in this arrangement. Robbing is more likely to occur when the hives are so close together; there is not the same convenience for working them; young queens are more likely to miss their hives after their wedding flight; and in most cases the bees of all the hives in the clump must be quieted while working at either one. When the hives are standing out singly there is nothing to impede rapid manipulation, which is always desirable when working large apiaries.

The hives should not be less than a clear six feet apart, and the rows eight feet, or, if space will allow, ten feet apart from centre to centre; this would give eight feet clear between the line of bottom boards. The position of the hives in each row should alternate with that of those in the rows in front and behind, as shown in the illustration. This affords a clear line of flight to each hive, and the person working them is outside that line. The front of the hives should face the North, or from that to North-East, but never to the West of North if it can be avoided.

#### BUILDINGS.—EXTRACTING HOUSE.

The extracting house or room may be entirely separate from all other buildings, but as a matter of economy, and convenience, it is, as a rule, best to have all the necessary tenements, such as extracting and honey store rooms, workshop and hive store room (the two latter in one compartment), and a comb storage room under one roof, and connecting with each other. I cannot too urgently impress upon those bee-keepers who are, or intend to be, in a sufficiently large way to need the foregoing conveniences, to put up a roomy and substantial building in the first place, and not try to do with anything of a makeshift nature. The building need not be an elaborate one; plain upright boarding and battens needing no lining, partitioned off, and made bee proof. Those at the Government Apiaries are built in this plain manner, on my design, in order to show how an efficient and cheap building may be erected by anyone capable of using a hammer and saw.

Fig 17 represents the ground plan of the first Government Apiary building erected at the Ruakura experimental farm, which only consisted of the extracting and store rooms; in all, 26 ft. long by 14 ft. wide. Subsequently a lean-to the full length of the house was added, 12 ft. in width. 10 ft. was partitioned off for a comb room, and the remaining 16 ft. serves as

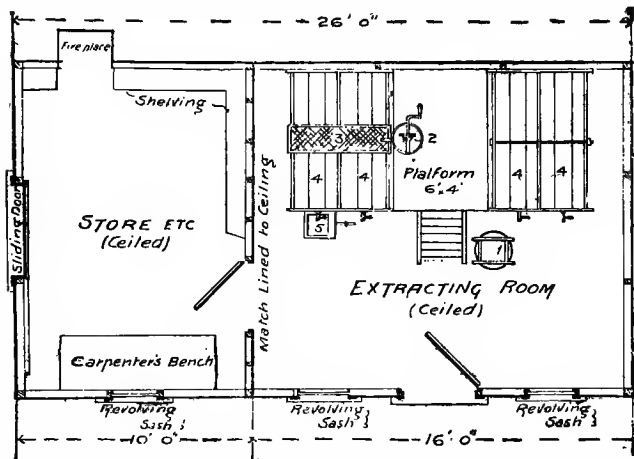

Fig. 17.—GROUND PLAN OF EXTRACTING HOUSE AND HONEY STORE ROOM.

a workshop and hive store room combined. Referring to Fig. 17, No. 1 is the uncapping can; 2, the honey extractor on the platform; 3, the honey strainer; 4 4, 4 4, two double honey maturing tanks; 5, a 56-lb. honey tin under the tap of the tank.

The platform on which the extractor is worked is, as shown, 6 ft. long by 4 ft. wide, and rises 4 ft. 9 in. from the floor. This allows height enough for the honey to run into the strainer over the honey tank, and to fill bulk honey tins direct from the taps. The extracting room is 16 ft. long, which affords space for a 4-foot double honey tank on each side of the platform and to get partly round them.

## WINDOWS.

I have already referred to the house being made bee proof, but at extracting time it is impossible to avoid bees being taken into the extracting room with the combs, when it becomes a question of adopting the best means of getting them out again quickly. The bees themselves, in trying to escape, fly to the windows, attracted by the light, and in some bee books it is recommended to fit up wire screens and small "Porter" escapes to the windows, which in my experience are of little or no use. In 1883 I adopted a plan of hanging the windows centrally, so that they could be swung half round, in which case, any bees clustering on the windows inside can be ejected instantly by giving the latter a half turn.

## COMB ROOM.

A comb room for storage of spare combs is an absolute necessity in a large apiary. It should be smoke tight, so that the combs may be fumigated to kill any wax moths that attack them. Upright studs of 3 in. by 2 in., put up on each side of the centre so as to leave a passage between, and battens running from them to the sides of the room, will afford convenience for the storage of some thousands of combs in a room of the dimensions suggested.

I have found it best to have the building on the East side of the apiary, about the middle of the rows—that is, supposing there are to be ten rows; then the centre of the end of the building should be opposite the fifth and sixth rows.

It should face the same way as the hives, and be as near the latter as possible. The extracting room should be in the end nearest the hives, and the honey store room at the other end (having a wide door), so that a horse and cart or waggon can be brought up to the building without being too close to the bees in their flight.



## MOVING BEES.

The moving of established colonies in hives furnished with the Hoffman self-spacing frames, so much in use now, is a very easy matter compared with what it was formerly with the loose-hanging frames; the frames can now be made secure in a moment by wedging them off from one side of the hive. The chief consideration after that is to obtain good ventilation.

When the bees are to be confined for two or three days or more, the best plan is to make temporary tops and bottoms for the hives out of 4 by 1 in. battens, just the outside dimensions of the hives when nailed together. The inner part between the battens to be covered with the ordinary queen cage wire cloth. The hive is set on one board, and another is placed on top, four 3 by  $\frac{5}{8}$  inch battens are screwed on to the boards connecting the upper with the lower one. This makes all secure and gives ample ventilation through both, when properly constructed.

Some provision must be made to give the bees water, and the best I know is to fasten a small sponge on the wire cloth on the upper board, and to keep it damp. The winter months, when no breeding is going on, is the best time to move bees. Brood when confined more than twenty-four hours is likely to die and become putrid, especially in warm weather. When travelling by train the hives should be placed with their frames parallel with the train, but when by waggon the frames should be across the vehicle.

## OUT-APIARIES.

When a person of some experience decides to become a specialist in bee-keeping, and to give his whole attention to bee-farming, he must sooner or later establish out-apiaries, that is apiaries apart, and at some distance away from, his first or "home" apiary. The number of colonies that can be profitably run in any one apiary depends of course, on the amount of bee forage available, and whether the locality within bee flight is occupied by other bee-keepers or not. If fairly free in this respect, and the pasturage good, from 100 to 150

would not be too many, taking many parts of New Zealand as my guide. I have myself run 200 colonies in one apiary with an average output of about 100 lbs. of honey per colony, and with another apiary of nearly 100 colonies less than two miles distant. Experience, however, is the best guide, and an observant man with his heart in his work will have no difficulty in deciding this question.

There is one point worth considering and that is, while it is not wise to overstock any one apiary to a large extent, it may pay better to do so a little rather than start another. For instance, say the home apiary would be fairly stocked with 100 colonies, it might be more profitable to put down 150 and get a little less average per colony, than to establish another several miles away, with all the trouble and expense of attending to it. It is quite possible to do better with larger and fewer apiaries, than with a greater number of smaller ones.

It will also depend upon the amount of bee pasturage in the surrounding district as to the distance the apiaries should be apart. If plentiful, three to four miles, or say four miles in every direction would be far enough. Those I know who have several out-apiaries make arrangements with owners of farming land for renting a plot of ground large enough for an apiary, and seemingly have no difficulty in getting the convenience.

#### OVERSTOCKING A DISTRICT.

It is of course conceivable that this may occur, but the chances of two or more large commercial bee farms being established so close together as to materially injure each other I think is rather remote. The last comers would be as badly off as the first, and it is hardly likely experienced men would act so foolishly toward themselves and each other.

## CHAPTER VI.

### HIVES, FRAMES, AND SECTION BOXES.

#### HIVES.

THE movable-comb hive has now become so familiar to every person taking ever so slight an interest in modern bee-culture that there is no necessity to describe the difference between it and a common box. Hives may be made of any size or pattern that may suit the fancy of the individual, but he will be wise to adopt the one in general use in the country he is residing in. In Australasia we fortunately have the "Langstroth" as

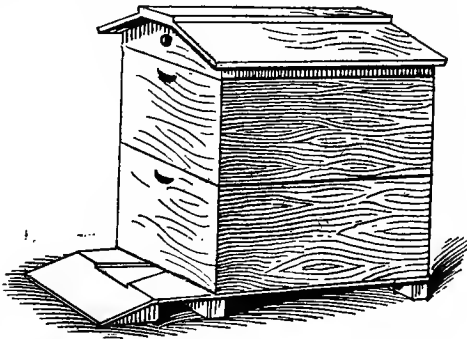

Fig. 18.—HOPKINS' LANGSTROTH HIVE.

(Two-story Hive, for raising Extracted Honey.)

practically the standard hive; in fact, there is no other kind in use in New Zealand. This is a very great advantage, as the hives and frames are interchangeable

over the whole Dominion. I had the honour of introducing this hive into Australasia in the season of 1877-78, and without altering the original dimensions I modified it a little in the direction I thought most suitable. The Langstroth hive is used now in all parts of the world with the exception of Great Britain, where they use a smaller one, the "British Standard," and the Langstroth in its simplest form is the one I now recommend.

#### LANGSTROTH HIVE.

The Langstroth hive complete consists of several movable parts—the floor and alighting boards (which may be attached if desired), the brood chamber or lower

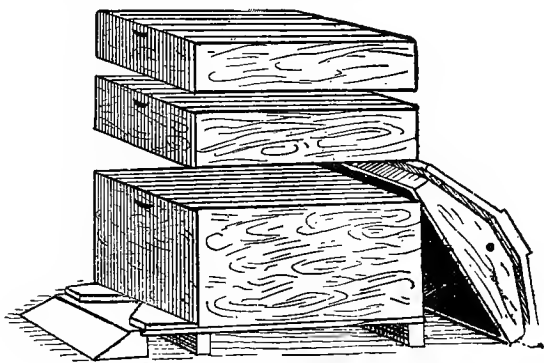

Fig. 19.—LANGSTROTH HIVE WITH TWO HALF-STORIES.

(For raising Comb-Honey in Sections.)

hive, the super (one or more), the frames and cover. The outside dimensions of the brood chamber are 20 $\frac{1}{2}$ in. by 16in. by 10in. in height, including the rabbet. The super used for raising extracted honey is exactly the same size, but the half-story supers that can be used either for raising extracted or comb honey,

while of the same length and breadth, are only  $5\frac{3}{4}$  in. in height. The floor or bottom-board is the same width as the brood chamber, but four inches longer, out of which a V-shaped piece is gouged at the front end of the board, three-eighths of an inch deep, for an entrance, which allows more or less ventilation to be given according as the body of the hive is pushed forwards or backwards on the board.

The brood chamber is intended to contain ten narrow frames of comb; the super, if worked for extracting, has generally nine of the same frames, the intermediate spaces being left a little wider than in the brood chamber. The half-story supers are made to contain either shallow frames, with section boxes, or a section rack. An inside covering mat is placed on top of the frames in the hive or super just under the cover. The stands and the bottom of the floor-board may be painted a dark colour; the hive itself is better if either white or a light tint; the top of the roof should in any case be nearly white, in order the better to cast off the hot rays of the sun in summer.

These hives can be procured at very moderate prices, and very complete in every respect, from the manufacturers. For the convenience of those who wish to put their own hives together and to save expense in the transport, they can be had in the flat, that is, all the separate parts complete and ready to be nailed together, and packed as close together as possible in crates or packages containing several hives. Should a beginner decide to purchase his hives in the flat, he should obtain one made up as a pattern, so as to avoid mistakes in putting the others together, though the following instructions will help him in this respect.

#### INSTRUCTIONS FOR MAKING THE HIVES.

The first important point to be observed is to use none but thoroughly seasoned timber that will neither shrink or twist after it is made up. Every corresponding part in all hives, be they two or two thousand,

must be exactly alike to be interchangeable one with the other. The thickness of the timber used principally throughout the hive is seven-eighths of an inch; and as one-inch boards—the nearest size most easily obtained—when well seasoned are a sixteenth less, there is just sufficient substance left to allow of a smooth surface being put on one side with a plane. The body of the

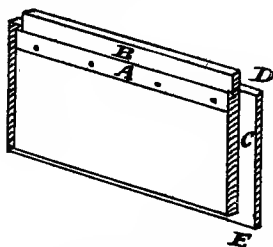

Fig. 20.—END OF HIVE (INSIDE VIEW).

hive, with which I will start, is 10in. deep, and takes exactly 5ft. 11in. of board to form the two sides and two ends; so that boards 12ft. by 1ft. will cut two bodies, allowing two inches for saw cuts and waste. I would advise getting 1ft. boards, as the exact 10in. can

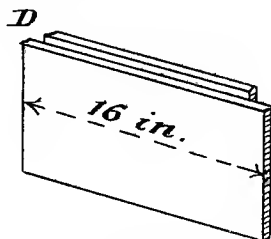

Fig. 21.—END OF HIVE (OUTSIDE VIEW).

be cut after they are seasoned. Plane the 12 by 1ft. board on one side, reducing the thickness to seven-eighths of an inch, or buy the timber already planed, and run a trying plane along one edge till the edge is

perfectly straight. Mark the depth (10in.) from the straight edge, and rip off the strip; now cut from your 12ft. board four pieces 16in. long for end pieces, and four 19½in. long, for sides, then set your gauge to mark three-eighths, and take each of your end pieces, lay them on the bench, planed side up, and run your gauge along the rough edges, marking for the rabbet D shown

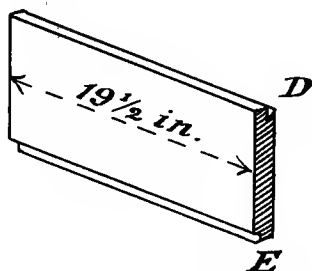

Fig. 22.—SIDE OF HIVE (INSIDE VIEW).

in Fig. 20. Next hold the pieces on their edges, and mark with the same gauge in from the planed side. This will show the piece to be taken out to form the rabbet D. The pieces should now be turned the planed edges up, and the same gauge run along the edges from the planed side of the board to mark for the rabbet E, shown in Fig. 20. Now lay the ends flat (rough side up), and mark with same gauge in from the edges for rabbet E, and also run the gauge down the ends of the boards from the planed sides to mark for rabbet C (Fig. 20). Before shifting the gauge, the rabbets on the side pieces can be marked. The rabbets D and E (Fig. 22) are marked exactly the same as the rabbets D and E in Fig. 20. We have now the rabbets D E and the edge of C marked. The gauge will then require to be set at seven-eighths of an inch to mark in from the ends of the end pieces on the inside for rabbet C, Fig. 20, and also down from the top edges for rabbet B, Fig. 20. All that is wanted now is to

reset the gauge to a quarter of an inch, and mark on top edges from the inside for rabbet B, Fig. 20.

The rabbets, being all marked, will require cutting out. The best tool for this purpose I have ever used was an iron plough (American). With this tool, fitted with a three-eighths iron and set to a three-eighths gauge, it will scarcely require the marking gauge to be used. By cutting out the rabbets D and E (Fig. 20) first, some little labour will be saved when cutting C. If a saw cut is put in across the latter it will expedite

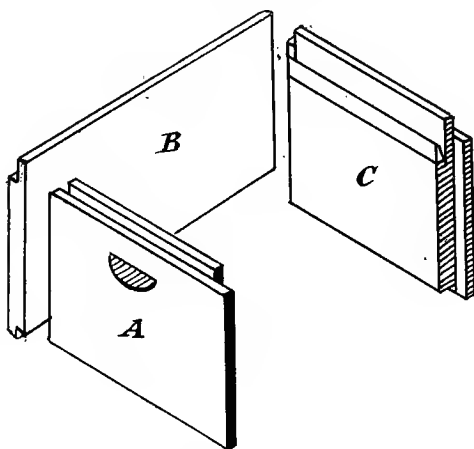

Fig. 23.—SHOWING HOW THE DIFFERENT PARTS OF THE HIVE GO TOGETHER.

the cutting. For C and B a seven-eighths iron will be required, with the gauge of the plough set to the proper depth. After the rabbets are cut, strips of tin,  $1\frac{1}{2}$  in. wide by 14 in. long, should be folded in the centre to form the metal supports A (Fig. 20). These are tacked on, as shown, so as to allow the upper edges to project above the lower part of rabbets about one-eighth of an inch. Metal supports, or, as they are



commonly but incorrectly termed, "tin rabbets," are for supporting the frames, the projecting ends of which rest on them; but I shall have more to say respecting these in another place.

The ends and sides being properly formed will have the appearance of the figures and will themselves suggest how they should be put together. Fig. 23 represents the two ends and one side nearly in place; the ends of the side pieces dropping into the rabbets *c* (Fig. 20) should fit nicely, and be firmly nailed with three  $2\frac{1}{2}$ in. wire nails at each end. These should not be driven through the end pieces into the sides, but through the sides into the ends, dovetail fashion.

#### BOTTOM BOARD.

For the platform of the bottom board a piece of board 2ft. long, 16in. wide, by 1in. thick, is required. Although this may be made out of two or more pieces,

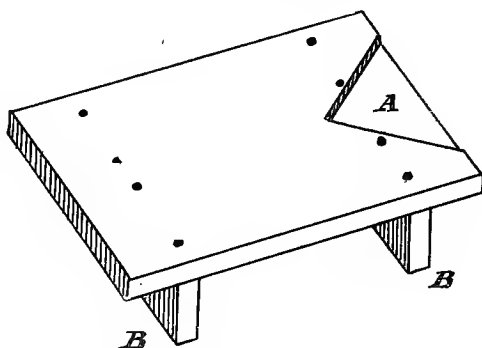

Fig. 24.—BOTTOM BOARD.

it is much better to have it in one, as the joints give facilities for moths and other insects to deposit their eggs where it is difficult for the bees to get at them. The entrance *A* (Fig. 24) is cut out of one end three-

eighths of an inch deep, starting  $1\frac{1}{2}$  in. from each side and running back 5 in. to a point, as shown. After marking it out, a saw-cut can be run on each side to save labour in chiselling. The stands B B are 4 in. wide,  $1\frac{1}{2}$  in. thick, and 16 in. long; nailed on edge, 3 in. back from each end. These pieces keep the hive a sufficient height off the ground and prevent the bottom board twisting.

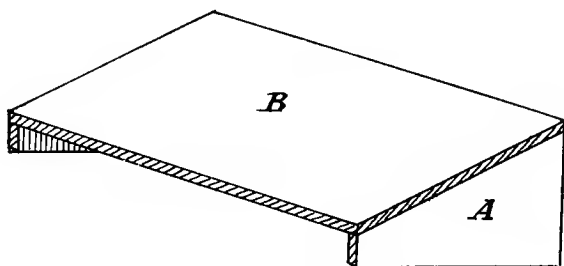

Fig. 25.—ALIGHTING BOARD.

This is a very necessary part of the hive. Placed in front of the entrance, it makes a capital landing stage for the bees, and thus saves many from falling to the ground when heavily laden. The platform B (Fig. 25) is 16 in. long, 9 in. wide, and five-eighths of an inch thick. The upper edge should be slightly bevelled, to fit snug against the bottom board. The pieces A are 8 in. long and 4 in. wide at their widest part, tapering down to  $1\frac{1}{2}$  in. at the outer end. The handiest way of making these is to cut them out of a board  $5\frac{1}{2}$  in. wide and 1 in. thick. Every eight inches of the board will make two without any waste and save a deal of cutting.

#### COVER.

This is a part of the hive that requires to be very carefully made. Leaky covers are an abomination.

The ends (Fig. 26) are made in seven-eighths of an inch timber, 16in. long, 4in. wide for  $1\frac{3}{4}$ in. in the centre, then tapering down to  $1\frac{1}{4}$ in. wide at each end. A rabbet, three-eighths of an inch wide by three-eighths of an inch deep, is taken out of the lower edges on the

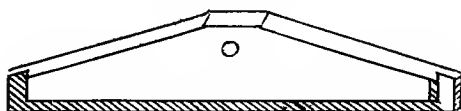

Fig. 26.—END OF COVER (INSIDE VIEW).

inner or rough side, to allow it to fit over the rabbet on upper edge of the body of hive, and another rabbet is cut in the ends, as shown, seven-eighths of an inch by half an inch deep, for the sides to house into. An

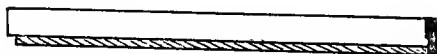

Fig. 27.—SIDE OF COVER (INSIDE VIEW).

inch hole for ventilation (shown in figure) should be bored in the centre, and have a piece of perforated zinc tacked over it. The side pieces (Fig. 27) are the same thickness as the ends— $19\frac{1}{2}$ in. long, 2in. wide on the

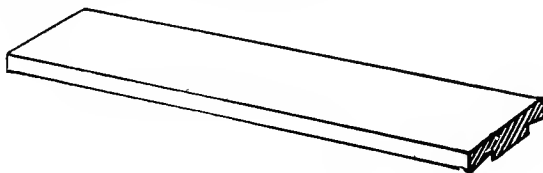

Fig. 28.—RIDGE BOARD OF COVER.

insides, and  $1\frac{3}{4}$ in. wide on the outsides, the upper edges being bevelled quarter of an inch to give them a similar slope to the end pieces. The lower inside edges of

these are rabbeted the same as the ends. The ridge board (Fig. 28) is 2 ft. long, 4 in. wide and seven-eighths of an inch thick. This should be rabbeted on the under side in a sloping manner, similar to the rabbets shown in the figure, tapering off from nothing at the edge to five-eighths of an inch at the deepest part. The width of each rabbet from the edge is  $1\frac{1}{8}$  in., leaving  $1\frac{3}{4}$  in. of the full thickness in the centre, corresponding with the top centre of end pieces. When making my hives by hand I had an iron fitted to my plough made the shape of these rabbets, which was the means of saving much time and labour.

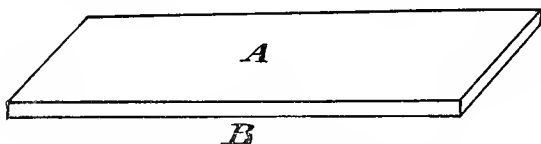

Fig. 29.—ROOF BOARD OF COVER.

The roof boards (Fig. 29) are made of five-eighths of an inch timber 2 ft. long by 8 in. wide, the lower edge being slightly bevelled to suit the slope of the cover.

To put the cover together, the sides and ends are nailed first; then place the ridge piece on, allowing it to project an equal distance at each end, but before nailing it, put on one of the roof boards in its place—



Fig. 30.—COVER COMPLETE.

the upper edge under the ridge, and nail through both ridge and board to the end pieces. Now nail the other board on in the same manner, and fasten both boards securely round the sides. The engraving (Fig. 30) shows the cover finished.

We have now gone through the whole hive, with the exception of the frames, and if every part is made according to the foregoing instruction, they will fit each other like a glove, and when two or three-story hives are required, it is only a question of having extra bodies similar to the one already described.

#### HALF-STORY BODIES.

These are made in exactly the same way as the full bodies, but only  $5\frac{3}{4}$ in. deep, and, as already explained, may be used for either extracted or comb honey.

#### NUCLEUS HIVES.

These are small hives generally used when queen rearing, and made of different sizes and shapes to suit the ideas of the queen breeder. By far the handiest are those made to take the regular frames used in the apiary and of a size that will take from two to four. They may be made out of light material, and in a more simple manner than the ordinary hive. The bottom board can be nailed on, and the entrance cut out of one end of hive; the figure does not show the bottom board. The width inside should be  $4\frac{3}{4}$ in. or 5in. to take three frames. A full explanation of the use of it is given in the chapter on queen rearing.

#### OBSERVATORY HIVES.

An observatory hive stocked with bees during the busy season is always attractive to non-bee-keeping friends and visitors. They are now supplied by hive manufacturers at very reasonable prices, and can be readily stocked in the summer season from one's own apiary by transferring a frame well stocked with bees and the queen from one of the ordinary hives.

#### PAINTING HIVES.

It is always advisable when putting hives together to give the joints a coat of paint and to paint the whole of the hives three coats before using them. The paint

should be of a light colour, a very light slate colour will stand better than dead white, and the last coat should be zinc paint. The bodies will then stand for two years but the covers should be painted every autumn.

#### HIVE CRAMP.

A hive cramp of some kind is absolutely necessary when putting hives together to get the parts firmly in their places, and to hold them true while nailing them,

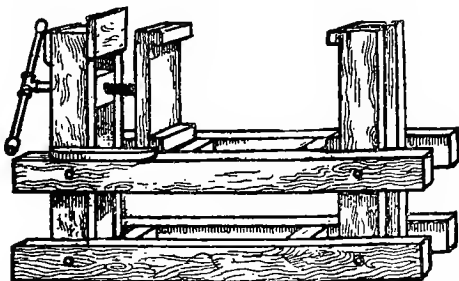

Fig. 31.—HOPKINS' HIVE CRAMP.

so that they may stand a bit of rough handling afterwards without getting out of the square. I don't know of anything better for this purpose than the cramp shown in Fig. 31, and where there are a good few hives to put together it will pay to buy or make one. The end pieces of the hives are placed against the jaws of the cramp, and the side pieces top and bottom; they are then screwed together and nailed. The platform of the cramp forms a good solid base to nail on, while the top is just high enough for nailing conveniently. The author has had one in use since 1878, and there is one in use at each of the New Zealand Government Apiaries.

## A CHEAP FRAME HIVE.

There are no doubt many pioneers in the back blocks who would like to keep a few colonies of bees to raise honey for family use, but find it beyond their means to obtain hives from the manufacturers owing to the heavy cost of carriage. To such I would say that a very good hive of the Langstroth pattern may be made out of a sound kerosene-case, which is of the same dimensions inside, and takes the same number of frames as the regular Langstroth. The following instructions are taken from my Bulletin No. 18:—

“Secure a complete and sound kerosene-case, and carefully knock off one of the broad sides; nail on the original cover, which will now form one of the sides. If the sides of the case are not level all round, build them up level with fillets of wood. The inside depth should be 10in. Next nail on at each end, half an inch below the inside upper edges of the case, to suspend the frames from, a fillet of wood three-eighths of an inch thick by three-quarters of an inch wide, and the length of the inside end of the case. The frames when suspended from these should be a clear three-eighths of an inch off the bottom of the hive. An entrance three-eighths of an inch wide by 6in. long should be cut out of the lower part of one end of the case, and a small alighting-board be nailed on underneath, projecting from 2in. to 3in. in front. A loose bottom board can be arranged if thought desirable.

Top or surplus honey-boxes can be made in the same way, but will not require a bottom.

The cover can be made from the side knocked off, and should have small fillets, 1in. wide, nailed on right round the edge, to overlap the body. Cover the top with ruberoid or other waterproof material, and let it overlap the edges. A capital waterproof covering can be made by first giving the wood a good coat of thick paint, and, while wet, laying on open cheese-cloth (not butter-cloth), letting it overlap the edges, and painting over it. The paint on the wood will ooze through the cloth, and the covering will last for years—no tacks are needed. Light-coloured paint is best, as with this the hive will keep cooler when exposed to the sun than if painted a dark colour.”

Self-spacing frames can be either purchased or made on the spot in the manner detailed further on.

The actual outlay for such a hive, allowing 4d. for the box, would be under 1s., providing the person makes his own frames.

There are a large number of these hives in use at the present time in New Zealand.

When setting the hives out, keep them raised five or six inches off the ground on bricks at each corner, so that there may be good ventilation underneath.

#### SELF-SPACING FRAMES.

The "Hoffman" pattern of self-spacing frames, Fig. 32, is now generally used, and they are no doubt

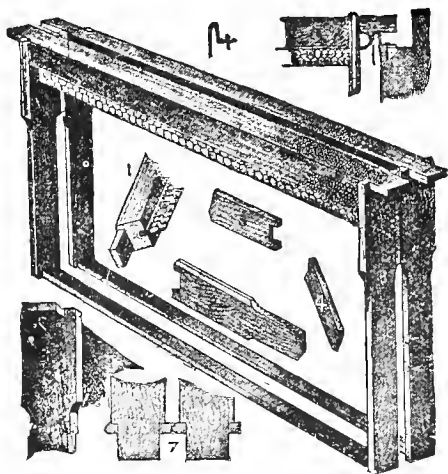

Fig. 32.—THE HOFFMAN BROOD AND EXTRACTING FRAMES.

the best of the kind yet invented. They can be easily and rapidly handled, and the hives can be shifted about at a moment's notice without having to pack the frames, and without the risk of killing bees,



These frames being difficult to make by hand it is advisable to purchase them from the manufacturers.

There is, however, a device made of strong tin, termed a metal spacer, shown in Fig. 33, which folds over the top bar and is tacked on edges of end bars. They keep the frames the correct distance apart, and may be purchased from the manufacturers of bee appliances. With the use of these a person can readily make his own self-spacing frames, but excepting in cases where the cost of carriage is expensive it will be cheaper, when time, trouble, and cost of timber is con-

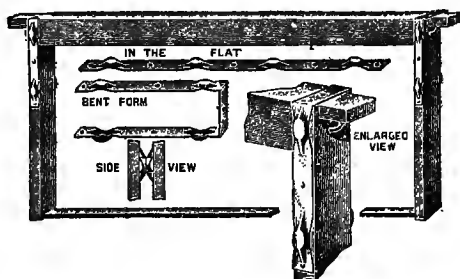

Fig. 33.—METAL-SPACED FRAME.

sidered, to purchase them ready made. The dimensions are:—Top bar, 19in. long, and seven-eighths of an inch square; shoulders are cut out of the ends 1in. deep, leaving a thickness on ends of top bar of five-sixteenths of an inch. End bars  $8\frac{1}{2}$ in. long, seven-eighths of an inch wide, and three-eighths of an inch thick. Bottom bar,  $17\frac{3}{4}$ in. long, three-quarters of an inch wide, and quarter of an inch thick.

#### SHALLOW EXTRACTING FRAMES.

Shallow frames are of great advantage where the honey is of a dense nature, requiring increased speed in the revolutions of the Extractor to throw it out,

Full depth combs, even when wired, are liable to be damaged when a high speed is necessary, but the half depth combs, needing no wire, stand a much greater strain without risk. The frames are made in the same



Fig. 34.—SHALLOW EXTRACTING FRAME.

way as the larger ones, except that the top bar need be only half as thick, and the inside depth,  $4\frac{1}{4}$  in., it will then fit an ordinary half-story body.

#### BROAD SECTION-FRAMES.

These are made to hold four sections in one tier as shown in Fig. 35. The old scheme of having two tiers in full depth frames has been entirely discarded by progressive bee-keepers. The top and bottom bars are the same length as the large frames, but slightly over  $1\frac{1}{8}$  in.

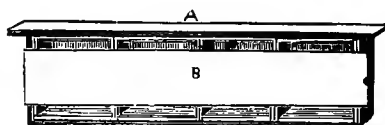

Fig. 35.—HALF-STORY FRAME WITH SECTIONS AND TIN SEPARATOR.

wide and three-eighths of an inch thick, while the end bars are  $1\frac{7}{8}$  in. wide, and  $4\frac{1}{2}$  in. long; so that the inside of frame is the same as the section box— $4\frac{1}{2}$  in. deep.

#### SECTION HOLDERS.

In America, where very large quantities of section honey are raised, all sorts of devices are used for holding sections while on the hives. Frames without top bars, except the projecting ends, which allow the sections to be inserted and removed easier and quicker, and section racks without frames are the two popular methods.

#### NUMBER OF FRAMES TO A HIVE.

The original Langstroth Hive, as constructed by the Rev. Langstroth himself, contained ten frames, and this is the number generally used throughout Australasia. There was an agitation some time back in favour of an eight-frame hive, but it is now seen that the ten-frame hive is the best size for all purposes. The half-stories when used with the shallow extracting frames take the same number—ten—but only seven of the section frames.

#### MATS FOR COVERING FRAMES.

Mats answer two purposes—for keeping the bees below the tops of the frames, and conserving the warmth of the hive. They may be made of any thick, coarse material, like light sacking stuff, and should fit accurately over the frames.

## SECTION BOXES.

For the raising of comb honey, which many people prefer, nothing could be better than the small one-pound section box as now made. Though boxes of various dimensions are sometimes used, the most popular one is the  $4\frac{1}{4}$  by  $4\frac{1}{4}$  inch section, which just weighs one pound when full.

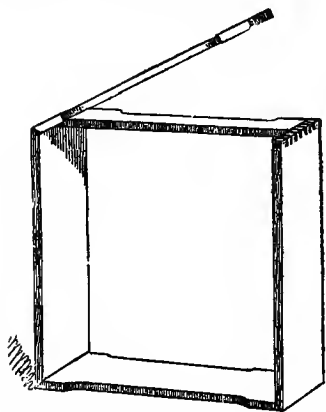

Fig. 36.—ONE PIECE SECTION BOX, PARTLY FOLDED.

The American basswood section is no doubt the most popular, though very good ones are now manufactured in Australasia. They are made in one piece, so that they can fold to form the box as in Fig. 36. A saw cut is made in one end, so that when one-half the end is folded the comb

foundation can be inserted, and the other half closed down upon it. Section boxes and all other material mentioned in this Manual can be obtained from hive manufacturers.

## SEPARATORS.

To raise section honey in the best marketable form, separators of some kind, as divisions between the frames, are indispensable. Both tin (see Fig. 35), and thin wood slats are used for the purpose. The latter, being better non-conductors than tin separators, are on that account preferable for use in spring, when warmth is so essential to induce the bees to commence work in the sections.

## CHAPTER VII.

### COMB-FOUNDATION.

COMB-FOUNDATION is simply a thin sheet of beeswax upon which the bases of the honey-comb cells, and a very slight portion of the side walls have been impressed; upon this foundation the bees construct the complete comb.

As a real practical aid to bee-culture it first came into use in 1877, though several attempts had been previously made to make it commercially useful, but without success.

It would be impossible to estimate its great value in the progress of commercial bee-keeping.

It has been greatly improved in its manufacture during late years, the old style of sheeting it from molten wax has gone completely out of date. The "Weed" foundation (named after the inventor), is quite a superior article. Though soft, it is tough and non-brittle. It is made direct from blocks of wax under great pressure; the process is patented by the A. I. Root Company, of America. Excepting in the

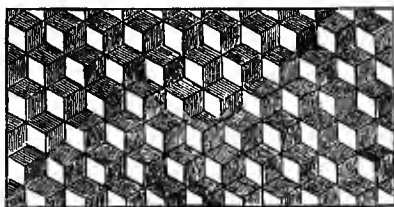

Fig. 37.—COMB-FOUNDATION.

cases of a few private bee-keepers, who make up their own wax, none of the old style foundation is now made. The cost of the patent together with the machinery puts it out of the question to set up the plant in New Zealand, especially since wax has advanced so much in price, and is so difficult to get. It really pays better to sell the wax raised and purchase "Weed" foundation, than to bother with the making of the old style article, for in addition to its other advantages the former will go at least one-third further than the latter.

#### THE USE OF COMB-FOUNDATION.

Beginners are apt to undervalue the use of full sheets of comb-foundation, and place strips in the frames instead, leaving the bees to do the rest. As I went fully into this matter in my "Bulletin No. 18, on Bee-Culture," issued by the New Zealand Department of Agriculture, I cannot do better than quote the article:—

"The success of modern bee-culture hinges almost entirely in the first place on securing complete control over the breeding, and this can only be obtained by compelling the bees to build whatever kind of comb is desired. Under natural conditions, or when in hives and allowed freedom to construct their combs, they invariably build a goodly proportion of drone-comb, which is subsequently utilised for breeding drones. This accounts for the large number of drones to be seen in box hives, or where no attempt has been made to control breeding. Drones, as most people are aware, are non-producers—that is to say, they do not gather honey, or even, so far as we know, do any work in the hives. They are physically incapable, but they consume a large quantity of food gathered by the workers, and where many are present the yield of honey from that hive, and consequently the profit, will be considerably curtailed. Some drones are needed for the impregnation of young queens, but it is found in practice that a sufficient number for this purpose will be bred, even when the breeding of them is restricted as much as possible, by making the fullest use of worker-comb foundation.

The difference between worker and drone comb is in the size of the cells, the former measuring slightly over five to the inch, and the latter a little over four. The comb-founda-

tion obtained from manufacturers is invariably impressed with the bases of worker-cells, so that it is impossible, unless by accident some portion has stretched, for the bees to build other than worker-comb on it.

Securing control over breeding is not the only advantage gained by a free use of comb-foundation. For instance, a fair swarm of, say, 5 lb. weight hived upon ten sheets of comb-foundation in a Langstroth hive will have in twenty-four hours, in an average season, several of the sheets partially worked out and a goodly number of eggs deposited in the cells, and in thirty-six hours the queen can henceforward lay to her full extent. In from a week to nine days (depending upon the weather) the whole ten sheets will be worked out into worker-combs, and a great deal occupied with brood and honey, and the hive will then be ready for the top or surplus honey super. In twenty-two or twenty-three days young worker-bees will begin to emerge, and from this on the colony will grow rapidly in strength from day to day.

Contrast this favourable condition of things with what takes place when only narrow strips of comb-foundation are furnished. It will take under the same conditions a similar swarm from four to five weeks to fill the hive with comb, and then there will be a large proportion drone-comb, which is the very thing to guard against. Consider what the difference in time alone will make in the profitable working of a hive, especially in a short season. Then, again, with regard to the difference in the initial expense between using full sheets and strips, which seems to influence many beginners in favour of the latter system: Even in that there is a gain in favour of the method I am advocating. For instance, the cost of filling the ten frames with sheets of best comb-foundation would be (including the expenses of getting them) about 4s.; in small quantities and with strips—say, two sheets—10d.: an apparent saving in the first instance of 3s. 2d. We must then consider the matter from another point of view.

The consensus of opinion among the most experienced bee-keepers is that there is an expenditure of about 12 lbs. of honey in making 1 lb. of wax—that is, the bees consume that quantity of honey before secreting 1 lb. of wax. The ten sheets of comb-foundation weigh 1½ lbs. and cost 4s. For this there would have to be an expenditure of 18 lbs. of honey, which, at the average wholesale price of 4d. per lb. is 6s., so that there is a saving of 2s. in favour of the full sheets, to say nothing about all the other advantages gained.

This shows clearly enough, I think, the advantage of making the fullest use possible of comb-foundation."

## FASTENING FOUNDATION IN FRAMES AND SECTIONS.

The "Hoffman Self-Spacing Frames," which I recommend, have two grooves in the underside of the top bar, one in the centre for the foundation, and the other alongside for the wedge (which is furnished with the frames) to secure the sheet. The wedge, after the edge of the sheet has been inserted in its groove, should be pressed well down till its surface is level with the frame.

The shallow or half frames have one groove only into which the foundation is inserted, a little melted wax must then be run along on each side the sheet to secure it, taking care that the wax is not too hot or it will melt the sheet instead of fastening it.

A very useful instrument for this purpose is shown in Fig. 38. A brass tube half-an-inch in diameter and six inches long, tapering, and at the apex there is a small hole. On one side, in the handle, is bored another small hole which may be opened or closed with



Fig. 38.—VAN DEUSEN WAX-TUBE FASTENER.

the thumb. When the tube is stood up in a cup of hot wax the air will escape from the upper hole, and the wax flow in at the other small hole at the bottom. The thumb is closed over the upper one, the instrument is drawn out of the wax, and the point is then slowly drawn along. A glance at the split top section, Fig. 35, will of itself suggest the method of fastening the foundation.



## WIRING FRAMES AND FOUNDATION.

To strengthen the combs thin wire can be first run through the frames and then embedded in the foundation, so that the combs when built may have several wires running through them. This keeps them straight within the frames, and from sagging or bulging; they can then bear the strain of the extractor much better than unwired combs.

The end bars of the frames, as now sold, have the holes already pierced for the wire, about two inches apart, so that the wires run horizontally instead of perpendicularly as before. Number 30 tinned wire is used; and if cut off into the required lengths when there are a number of frames to do, it will be found more convenient than cutting one at a time. Find the length of wire required for one frame, allowing sufficient to wind round a tack at each end, then cut a thin batten about three inches wide, and just the length that the ends of the pattern wire will meet round it end ways. The wire from the spool can now be wound around the batten and after sufficient is on the batten the wires should be tied together in three or four places, and be cut through at one end. Put a large nail through the spool and drive it firmly into a bench inclining the top from you, the wire can then be unwound from the spool without trouble.

## EMBEDDING THE WIRE IN FOUNDATION.

Cut an inch board (A in Fig. 39) a little larger than the size of the frame; on this screw another piece, B, three-eighths of an inch thick, cut slightly smaller than the inside of the frame, letting the grain of each board cross that of the other, which will pre-

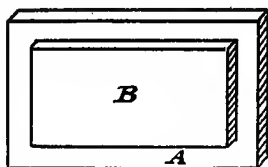

Fig. 39.—WIRING BOARD.

vent twisting. Lay a sheet of foundation on the board B, and a wired frame over it, resting upon the lower board A. One edge of the sheet should be close against the top bar of the frame. The wires can now be embedded by the use of the spur wire embedder (shown in Fig. 40), which is provided with teeth set something like the teeth of a saw, so as to straddle the wire while in the process of embedding it. The comb-foundation should of course, be warm enough to be pliable, otherwise the wire will not embed itself.

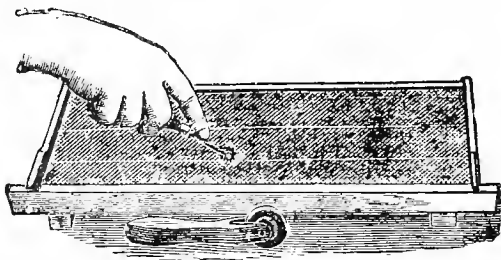

Fig. 40.—SPUR WIRE EMBEDDER IN USE.

### AXIOM.

“ THE ESSENCE OF ALL PROFITABLE BEE-KEEPING IS CONTAINED IN OETTL'S GOLDEN RULE—KEEP YOUR STOCKS STRONG. IF YOU CANNOT SUCCEED IN DOING THIS, THE MORE MONEY YOU INVEST IN BEES THE HEAVIER WILL BE YOUR LOSSES ; WHILE IF YOUR STOCKS ARE STRONG, YOU WILL SHOW THAT YOU ARE A BEE-MASTER AS WELL AS A BEE-KEEPER, AND MAY SAFELY CALCULATE ON A GENEROUS RETURN FROM YOUR INDUSTRIOUS SUBJECTS.”

*Langstroth.*

## CHAPTER VIII.

### THE HONEY EXTRACTOR AND EXTRACTING APPLIANCES.

VAST improvements have been made in honey extractors since the first one came into use. The "Novice" Extractor, with its fixed comb-baskets introduced at an early date in modern bee-keeping, by A. I. Root, was a great improvement on the original one, but this is rapidly being pushed aside for the more useful reversible basket extractor, which is far and away the most profitable from every point of view.



Fig. 41.—FIXED-BASKET EXTRACTOR.

In the fixed basket extractors the combs after being relieved of their honey on one side must be lifted out to be turned, and this, when the combs are extra heavy with honey, must be done two, or perhaps three times, taking up much time, and running great risk of breaking them.

#### REVERSIBLE BASKET EXTRACTORS.

My first reversible basket extractor—Fig. 42—was very substantial and complete. It had six baskets, all of which could be removed for cleaning. It was subsequently furnished with side gearing, when it ran splendidly.

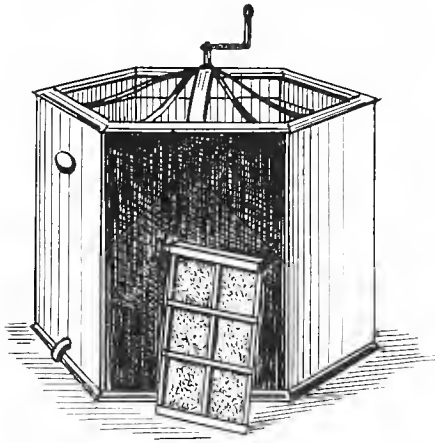

Fig. 42.—REVERSIBLE SIX-COMB HONEY-EXTRACTOR  
WITH ONE BASKET DETACHED.

*As designed and used by the Author at the Matamata  
Apiary, New Zealand, in 1883 and following years.*

In the latest reversible extractors the extracting can be done automatically by getting up a decent speed and throwing the extractor out of gear. As the gearing runs on ball bearings, the frame of baskets with their combs will continue revolving and extracting the honey for a long time. The baskets can be reversed by pulling the lever working the break while they are in motion, so that as labour-saving machines they seem almost perfect. Automatic extractors are now made in all sizes, two, four and eight combs, but the two and four are mostly used. The principle is the same in all extractors, whether they have fixed or reversible baskets: the honey is thrown or extracted from the combs by centrifugal force, first from one side and then from the other. The combs, after leaving the extractor, can be returned to the bees to be refilled.

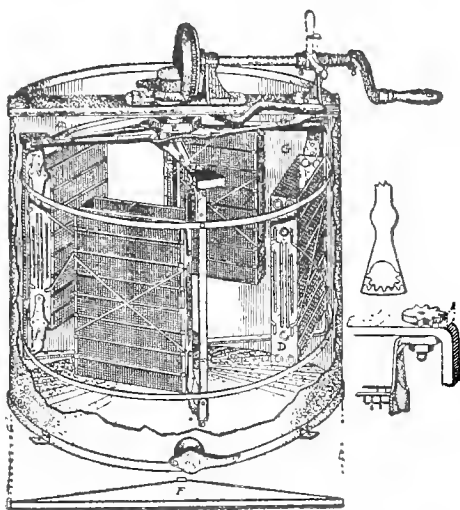

Fig. 43.—“ AUTOMATIC ” FOUR-COMB REVERSIBLE EXTRACTOR.

#### MOTOR POWER FOR EXTRACTING.

Small oil engines of one, or one and a-half horse power are now being used in some of the large apiaries—several are in use in New Zealand. They are not only useful to run large extractors, but can also be used for running machines for hive making and other purposes. Some of New Zealand's bee farmers, who have motor cars for running between their out-apiaries, fix an extra wheel for carrying a belt on the front gearing, and use the power for driving their extractors.

#### UNCAPPING KNIVES.

When preparing combs for the extractor the cappings of all honey cells that are sealed must be removed. Special knives differing somewhat in pattern, are used for this purpose, but the one in most general favour and

the one I prefer is shown in Fig. 44. It is, as can be seen, in the form of a trowel, but is thicker in the blade, and has bevelled edges sharpened from the under



Fig. 44.—BINGHAM UNCAPPING KNIFE.

side. With the aid of one or more of these knives, kept in first-class order, a person after a little practice

can, with up and down strokes, shave off the cappings easily and cleanly with little injury to the cells themselves.



“DADANT” UNCAPPING CAN.

Fig 45.

#### UNCAPPING CANS.

One cannot, however, avoid cutting into the honey sometimes, and something in the form of a can to catch the cappings is necessary. The “Dadant” uncapping can, Fig. 45, is a very good one and largely used. It is in two parts, upper and lower, the former acts as a strainer, and slides a short distance into the lower half. A wood frame fits

on top, upon which the comb rests while uncapping it. The cappings fall on to the wire cloth strainer through which some of the honey drains, to be drawn off by the tap at the bottom of can.

The "German Steam Wax Press" (see Chapter IV., Fig. 12) is also very useful as an uncapping can and honey press, in addition to its use as a wax press. A wood frame for uncapping purposes, similar to the one shown on the "Dadant" can is furnished with each press. When needed as an uncapping can, the screw is taken out and the frame fixed on top. After the draining of the honey ceases, the screw can be put in, and considerable more honey may be obtained from the cappings by pressure. It is rather small, and where there is much uncapping to do more than one would be needed.

#### CAPPINGS MELTER.

There is no gain saying that the ordinary method of dealing with cappings as detailed above is at best a messy, unsatisfactory, and slow process, and several attempts have been made to overcome the difficulties. The attempts have been in the direction

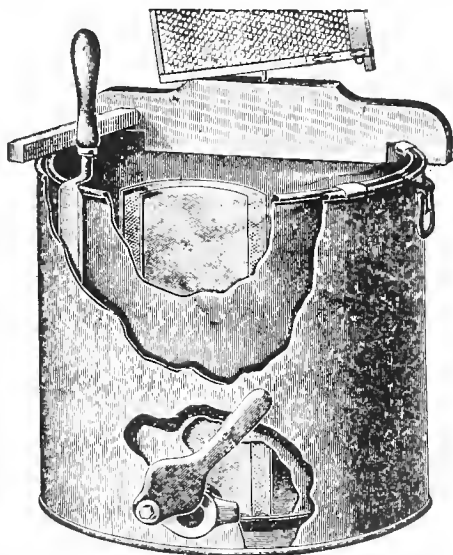

Fig. 46.—ROOT CAPPINGS-MELTER.

of arranging some heating apparatus by which the cappings shall be at once melted, and the honey and wax separated as the work proceeds. Any apparatus that can do this in a satisfactory manner will be a boon to apiarists, for besides economy in time and labour, it will also save a large quantity of honey that now unavoidably goes to waste.

Several cappings-melters have been introduced, but they have either been unsatisfactory or too complicated and costly to come into general use. The A. I. Root Company, after much experimenting, brought out the melter shown in Fig. 46, which is sold at a reasonable price, and is claimed to be a very satisfactory machine. It is a double-jacketed can, the space between the inner and outer walls being filled with water, the can is then set over an oil stove and kept at a steady temperature a little above the melting point of wax. A wire screen is fixed at the back of the tap to prevent any unmelted cappings running through. The cappings, as they fall from the comb, melt, and the wax with the honey runs through the tap (which must always remain open), into any utensil placed to receive them. On cooling, the wax cake floats on the honey, and is readily separated from it. Too much heat spoils the flavour of honey, but I shall have more to say on this point later on.

#### AXIOM.

“ A MODERATE INCREASE OF COLONIES IN ANY ONE SEASON WILL, IN THE LONG RUN, PROVE THE EASIEST, SAFEST, AND CHEAPEST MODE OF MANAGING BEES.”

*Langstroth.*



## CHAPTER IX.

### HANDLING BEES.

THE best that any writer can do on this subject is to give a few hints, for in my opinion no amount of book teaching will do as much to give confidence to the novice as a few minutes in the presence of an experienced bee-master when going through his hives. I therefore advise all who contemplate keeping bees, who cannot go for a season with some established bee farmer, to go as often as possible and learn all they can at a well established apiary.

There are certain rules to be observed to secure tolerable freedom from stings:—(1), Avoid jarring the hive or frames; if anything is difficult to move, such as the cover, or a frame, quietly prise it apart without jarring; (2), Never stand in the line of flight to a hive, and do all the manipulations from the sides, never in front; (3), A novice should never handle bees on dull, showery days, nor after sundown; (4), Never strike at a bee, but if timid and unprotected by a veil, bow the head slightly and walk away. After confidence has been gained by experience, a person may take liberties, but it is better to be cautious at the commencement.

#### BEE VEILS AND SMOKERS.

A good bee veil fixed over a stiff-brimmed hat of some kind is a necessity, as it protects the face and gives the wearer greater confidence. They can be made of book muslin, with or without Brussels net in front, tarlatan, or mosquito netting, but should be large enough to stand out from the face, and come well down the shoulders, where it can be tucked in

under the waistcoat. Some veils have a piece of fine wire netting sewn in front of the face.

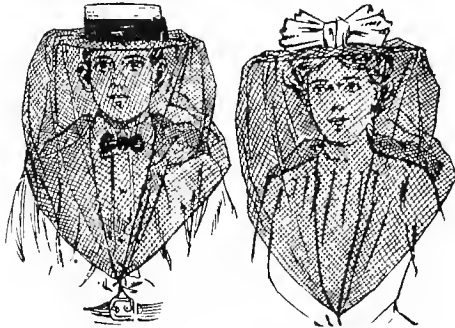

Fig. 47.—BEE VEILS.

A good smoker is also a necessity, for smoke, as a rule, is the handiest, least harmful, and one of the most efficient bee quieters known. A few puffs of dense smoke blown into the entrance of a hive is sufficient to drive the bees to their honey, and to gorge themselves ready for flight to a new home, when in this condition they may be handled safely. There is no need to try to stupefy bees, for if too much smoke is administered they will pour out of the hive, which is not desirable.

I have used a number of different kinds of smokers, but like the two herein illustrated the best, and of the two I prefer the "Vesuvius," because it is a breech-loader, and in that respect the handiest. Some beekeepers prefer the other; they are both good.

#### FUEL FOR SMOKERS.

Though dry rotten wood makes excellent fuel, giving out dense smoke, it is not always readily obtainable, but old sacking can, as a rule, be procured anywhere.

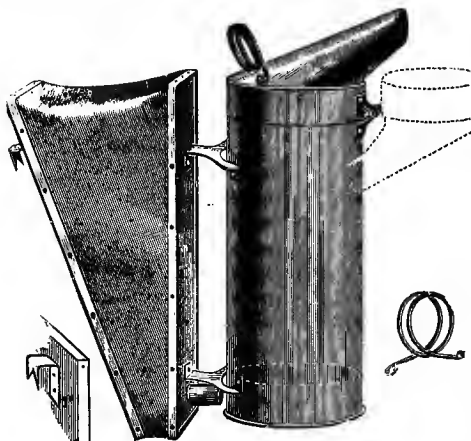

Fig. 48.—CORNEIL SMOKER.



Fig. 49.—VESUVIUS BREECH-LOADING SMOKER.

When dry, and cut into strips about five inches wide, and rolled up loosely of a size to nicely fit into the barrel of the smoker nothing could be better. If a number of rolls are made and dipped at one end in a solution of saltpetre and dried, they can be set alight at a moment's notice, and are always ready.

#### GLOVES.

Rubber, and oiled cotton gloves, for protecting the hands can be obtained, and are no doubt useful to those only keeping a hive or two of bees as a hobby, and who handle them but rarely. The best are those that leave the ends of the fingers free, but any kind of glove would be a nuisance to those who make a business of bee-keeping.

#### CURE FOR BEE STINGS.

When a person takes up bee-keeping and intends to carry it out properly, he or she must make up their mind to put up with stings occasionally. It is impossible to work among bees without being stung now and again. Though very painful to beginners sometimes, and the occasional cause of much inconvenience, they are rarely dangerous. I have known of one or two cases during my thirty-six years' experience with bees, when there was a partial collapse after being stung, but the administration of a fairly strong dose of brandy brought them round, without any painful after effects. I believe in such cases a strong stimulant is the best remedy that can be applied.

Beginners who suffer at first may console themselves with the fact that the more they are stung the less effect the poison will have on them; that is to say, the system becomes more immune to the poison as time goes on. I am often asked for the best remedy to allay the pain and swelling which with beginners almost invariably follow a sting, but have always to plead

ignorance, for I do not know of any good remedy. I have tried everything that has been recommended, with the hope that I might discover something to benefit others, but without success. Bathing the wound with very hot water is perhaps as good as anything. The sting being barbed cannot readily be withdrawn from any tenacious substance, like the human flesh, but is, with the poison bag attached, left in the wound, and the best way of removing it is to scrape it out with the finger, or thumb nail, so as to prevent pressing the poison bag.

#### HOW TO OPEN A HIVE.

Light the smoker and get it well going; then don the bee veil; blow a few puffs of smoke into the entrance of the hive, and wait a short time; then blow in another puff or two. The cover can now be removed, and as one corner of the mat is lifted blow a little smoke under it: by this time the bees are under control, and the mat can be removed altogether. Keep your smoker by you, and if bees get in the way, or "boil" up over the frames, give a little more smoke. The smoker will keep alight if stood on end, and to put it out, plug up the nozzle with a piece of cork or bunch of grass.

#### HANDLING THE FRAMES.

When the hives are made properly there is always a little play on one side of the frames when they are pressed together to allow the first one to be easily removed. A "hive-tool" like that in Fig. 50 is handy for lifting the first frame, and it also answers as a scraper. In fact, something of the kind is needed all the time one is at an open hive. A small screw driver also makes a



Fig. 50.—HIVE TOOL.

good hive tool, a scraper is needed in addition; and for this I like a small three-cornered ship scraper, to be obtained at most ironmongers.

#### COMB-HOLDER.

Something to answer as a comb-holder is needed to place a frame in with the adhering bees temporarily, when manipulating a hive. An empty hive will answer, but is rather clumsy. One like that shown in Fig. 51 is easily made, and need not be larger than to hold at most three frames.

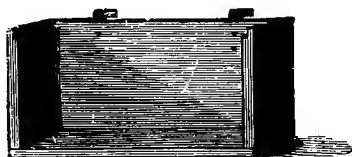

Fig. 51.—COMB-HOLDER.

It is usually necessary to look at both sides of a comb when one has a frame out of a hive. Beginners should be careful when turning a new comb heavy with honey on a warm day, or it might fall out of the frame. If, when holding such a frame breast high, the left hand is lowered and the frame swung round at same time, the other side of the comb will be brought into view upside down, without having put the slightest strain on it. By reversing the process, the comb is brought back to its original position.

#### AXIOM.

“ BEES MAY ALWAYS BE MADE PEACEABLE BY INDUCING THEM TO ACCEPT OF LIQUID SWEETS.”

*Langstroth.*

## CHAPTER X.

### TRANSFERRING BEES FROM COMMON BOXES TO FRAME HIVES.

WERE it not that this Manual circulates in parts of Australasia where common boxes are likely to be allowed as hives for some time to come, there would be no need for this chapter, as I feel proud in saying that all domiciles for bees, save frame hives, are illegal in New Zealand; and I look forward to the time, which I hope will not be long, when a similar law will be in force throughout the whole of Australasia.

Not very long since it was considered an advantage to save all the brood possible by transferring the brood combs as well as the bees, but it having been proved in so many cases to be the means of spreading disease, it has of late been deemed safest to transfer the bees only. I am very strongly in favour of this method, for, as I have proved, where colonies are not very badly affected, putting the bees straight on to full sheets of comb foundations will in most cases effect a cure; whereas if but slightly diseased combs are transferred, it means the maintenance of disease, and the great risk of spreading it. My plan of late years has been to drum the bees out of the boxes, put them on to starters, then in four days put them on to full sheets of comb foundation; in fact, treated them on the McEvoy plan, with successful results on every occasion. The old combs have either been burned or melted into wax.

#### DRIVING BEES FROM COMMON BOXES.

The best time to transfer is on any fine day after the honey season has set in, with warm settled weather, and a fair flow of honey on. The frame hive should be

located in its permanent position, the frames furnished with full sheets of foundation, or strips if the bees are to be "McEvoy'd," and the front of the hive raised off the bottom board a couple of inches or so, by stones or wood, at each corner. A mat should cover the frames and a sack be laid across the alighting board to prevent the bees falling to the ground when dumped down near the entrance. A box about the same size as the one the bees are in should be ready and the smoker going.

Blow a few puffs of dense smoke into the box, and put on a bee veil. In about two minutes give the bees some more smoke, then turn the box upside down, and put the mouth of the empty box over the bees, and drum away with two sticks on the lower box, on the sides running nearest parallel with the combs. To prevent the top box from shifting a long towel or sheet of some kind can be tied around the junction of the two boxes. In a short time the bees will begin to ascend, but the drumming may have to be kept up for from fifteen to twenty minutes before all the bees are in the top box. Set the one the bees are in down near the permanent hive, and carefully look among the old combs to see whether the queen is still there. As a rule she is among the very first to leave, but occasionally she is among the very last.

The bees clustered in the box are practically in the same condition as a swarm, and may now be dumped down on the sack in front of the new hive, close to the entrance; after the bees are all in, lower the hive on to the bottom board, and allow from six to eight inches of entrance space. The box of old combs should be taken away clear of all bees and be dealt with at once. The honey can be made use of, and the brood combs be burned with the box or be melted into wax. Should the weather after transferring be against the bees gathering nectar, feed them with sugar syrup (see Chapter XIII.) Any time from 10 a. m. till 3 p. m. is the best for transferring.



## CHAPTER XI.

### INCREASE—NATURAL AND ARTIFICIAL SWARMING.

THE question of increase of colonies, how to promote control, or to prevent it as far as possible, is one of very great importance, and one which should be earnestly studied, and be treated by each individual bee-keeper according to the special object he has in view. The experienced bee-keeper will have no trouble in deciding on this point, but the beginner needs the advice of an expert, and some beginners need it very urgently, to prevent them in their ardent desire for rapid increase from creating difficulties which in their inexperience they will be unable to overcome. I have known many such cases, and warn all beginners to "Go Slow," until sufficient experience has been gained to enable them to form an intelligent judgment as to their best course.

#### WHAT RATE OF INCREASE IS DESIRABLE?

Following up the advice just given to beginners, to "Go Slow," two or three colonies is a sufficient number to start with, to be increased the first season to four or six. By that time some experience will have been gained, and if the object be then to gradually work up a large apiary, a larger increase may be undertaken the second season. It is, however, well to bear in mind the excellent maxim laid down by "Father" Langstroth, viz :—"A moderate increase in any one season proves the easiest, safest, and cheapest mode of managing bees." A moderate annual increase is consistent with securing a fair return in honey, and this should be the aim of beginners.

## INCREASE BY NATURAL SWARMING.

In times past it was largely the custom to depend for increase chiefly upon natural swarming, but in modern commercial bee-keeping, there are better and more reliable methods in vogue which will be explained further on. I shall, however, mention the conditions which lead up to and cause natural swarming. The natural instinct for swarming, with which bees are endowed, is an admirable provision for the propagation of their race and its spread over any country favourable for their existence. When we recollect that it is only by means of the queens and drones that the race can be propagated; that these queens and drones cannot exist by themselves, or without the workers of a colony; that the queens require to be renewed periodically in order to keep up strong stocks, while the workers are only for a short season, and the drones for a few months; and, finally, that only one queen can as a rule be tolerated at a time in any colony, we cannot fail to be struck with admiration at the beautiful manner in which the swarming instinct is adapted to this state of things.

## CAUSE OF SWARMING.

The chief cause of swarming is an overcrowded hive, but it may be greatly accelerated by insufficient ventilation. There is, however, a season when the swarming instinct becomes energetic, and the desire to swarm intense. At such times the bees will occasionally contract what has been well named as the "Swarming Fever," and when in this condition they seem to get out of control, and will swarm in spite of all that we may do to prevent it.

In the ordinary course of things, the queen, with a comparatively small colony of workers, comes out of winter quarters, and under normal conditions starts the great work of egg laying in early August or later according to the latitude of the apiary. Breeding proceeds slowly, but steadily increases until the first young bees begin to emerge, when it advances more rapidly, and by October (early or late in the month

according to the season and situation) the hive will be getting overcrowded, and unless more room is given by enlarging the hive, the bees prepare for swarming.

#### PREPARATION FOR SWARMING.

Several queen cells are built in which eggs are deposited, and on the eighth or ninth day the cells are sealed; if the weather be favourable at this time the first swarm of the season comes off headed by the old queen. The bees having filled their honey-sacs with food, which will last them over three days, are ready at once to start comb building in their new home. The bees left behind in the old hive have several young queens maturing, lest one or more of them should fail, they have also drones flying at this time, and an ample stock of workers, maturing by degrees—therefore all the elements of their future strength. If the old queen has left with her swarm just when the first queen cells were closed then the first young queen will emerge in eight or nine days, and in the meantime the stock will have been recruited by a large number of young bees. If they still feel themselves over-strong, or are still actuated by a desire for swarming, the first young queens may go off with one or more after-swarms; if not, the first out will remain in possession of the hive, and all the others will be destroyed in their cells. In five or six days more the young queen will probably be fertilised, and shortly after will begin to lay eggs. This is the natural course of swarming, which provides for a multiplication of the self-sustaining stocks or colonies, and at the same time for a succession of young queens.

#### SIZE OF SWARMS.

The size of swarms varies according to the strength of the colonies from which they issue. If swarming has been delayed by enlarging the hive in time, the first swarm will be very much larger through being kept back.

It may contain from 5,000 to 8,000 more bees than if it had issued before the enlargement of the hive took place. A pretty close approximate of the number of bees in a swarm may be ascertained by weighing it. It has been usually calculated that in round numbers 5,000 bees weigh one pound, but allowing for the weight of food carried by the bees of a swarm, there is not likely to be more than 4,500 to each pound. Now a five pound swarm is a very fair one, but a swarm delayed in the manner suggested, will probably weigh nearer seven pounds. I have had them eight pounds.

If a swarm box be prepared and weighed, and the weight marked on the box it will be easy to find the weight of any swarm hived in it. Second swarms are always much lighter than first swarms, and beginners purchasing swarms, should always arrange to find their own swarm box, and to be supplied with swarms weighing not less than five pounds; they can then depend upon getting first swarms, with a laying queen.

#### SYMPTOMS OF SWARMING.

A certain guide to the approach of the first of the swarming season is the appearance of drones in Spring, and a sure sign that a colony is making preparations to swarm, is the building of queen cells.

#### SWARMING SEASON.

In the most northern parts of Australia the season commences in August, and in the extreme northern districts of New Zealand in September, but in most other parts of Australasia it commences in October, and continues frequently to the end of February.

#### PREPARING FOR SWARMS.

At the approach of the swarming period, everything requisite to facilitate the hiving of swarms should be in readiness, so that the bee-keeper can lay his hand on the necessary appliances at a moment's notice. All the new

hives likely to be required for the season's increase should be placed in position, according to the directions given in Chapter V., attention being paid to the proper bedding and levelling of the bottom boards.

#### ISSUE OF THE SWARM.

Swarms as a rule come off between 9 a.m. and noon, but sometimes a little earlier or later in the day.

There is a great stampede from the hive, the bees tumbling over each other in their excitement, as though they were glad to leave their old home to form a new colony elsewhere. The queen, as a rule, does not leave the hive among the first of the bees, but usually among the first third of them. After all the bees constituting the swarm have been whirling in the air for a short time, they usually settle on some convenient place close at hand; if on the limb of a tree or shrub, the cluster when all have settled will be in the form of a large bunch of grapes. The reason generally accepted for the swarm settling near at hand is, that the queen being laden with eggs, she is not in a condition to fly far, and therefore is obliged to settle to get rid of them in preparation for a long flight. When a second swarm headed by a virgin queen issues, the foregoing of course does not apply, but it may settle close at hand all the same or it may fly a long distance first.

#### DECAMPING SWARMS.

Sometimes, though rarely, the bees will have selected their new home before swarming; in such cases after circling in the air for a short time the bees will make straight for their chosen domicile, and unless that domicile happens to be some receptacle close at hand such swarms are usually lost.

#### TAKING AND HIVING SWARMS.

Swarms should always be taken as soon after the bees have settled as possible, as they cannot always be de-

pended upon to remain long before rising again. Sometimes they may remain for days and build comb, and at other times leave in less than one hour. A couple of sacks, a box, and a couple of small stones or pieces of wood will be needed. Spread one sack on the ground under the cluster, then hold the box with one hand right under the bees, as close as possible, and with the other hand give the limb or bough on which they are hanging a good jar, when most, if not all the bees, will drop into the box. Turn the box with the bees underneath on to the sack at once, and under the corners of one end place the two small stones, or pieces of wood, to raise the box so that the bees can go in and out.

Sometimes swarms settle in most awkward places for taking; a little ingenuity must then be exercised, always keeping in view that the best way is to get the bees down on a sack, or some cloth with the box over them, or as near to them as possible, and in this case brush the bees towards the box.

For the beginner, the best plan is to leave the box with the bees in till about 5 or 6 p.m. before hiving the bees, shading the box in the meantime with the other sack. When the bees are disturbed from the box soon after they have settled in it, to hive them, they are very likely to leave the hive and decamp, but when hived in the evening they settle down to work before morning, and are then, as a rule, safe.

#### HIVING.

The hive, as already suggested, having been placed in its permanent position, with its frames filled with sheets of comb foundation, the front should be propped up an inch or so off the bottom board with small pieces of wood to make a big entrance, and a sack should be laid across the alighting board to prevent the bees falling to the ground when dumped down. The bees can then be shaken as near to the entrance as possible; if one corner of the box be smartly dumped on the ground first, the jar will dislodge the bees from the cluster and they can

then be easily thrown out of the box. In a short time the bees will be all in the hive, when it can be lowered on to the bottom board, allowing an entrance of about eight or nine inches. In hot weather the hive will be the better of a temporary shade for a while, a folded sack across the cover will do.

#### HIVING BY CATCHING THE QUEEN.

I have hived scores of swarms, or rather made the bees hive themselves, by watching for, and catching the queen, as she was leaving the hive and caging her. When the swarm was circling in the air, I removed the parent hive to a new stand and put the new one in its place, the bees in a short time discover the queen is not with them and back they come to the old stand and into the new hive, when the queen can be liberated at the entrance to run in with them, or can be put in under one corner of the mat. The new hive may remain where it is, or be removed when the bees are all in, and the old one be brought back.

I shall refer to hiving with clipped queens in the chapter on Queen Rearing. Patent swarm catchers that are figured in some bee books, so far as my experience goes, are of little or no use, and not worth the trouble of making or describing.

#### PREVENTION OF SWARMING.

The most effectual method for the prevention of swarming is to give ample working room in the hives at all times during the swarming season, and to see that they are well ventilated. Extra working room is given in the first place by adding one or more stories to the hive, and later on by the use of the extractor, and in the case of raising section honey, removing the sections directly they are finished, and substituting empty ones. Abundant ventilation may be secured in hot weather by pushing the hive forward until the front overlaps the alighting board a couple of inches, and if need be raising the cover a little. It should be remembered that the extra

room and ventilation must be provided before preparations have been made for swarming by the building of queen cells, otherwise the provision will be of little use in this respect. The removal of queen cells alone only temporarily delays swarming, for when the bees have got that far towards it, in nine cases out of ten they will not be content till they do swarm. In adding top boxes the empty one should always be placed next above the brood chamber and under any others already on.

#### PREVENTION OF AFTER-SWARMING.

This, as compared with the previous question, may be considered an easy matter. In the ordinary course of events a second or after-swarm may be expected in eight or nine days after the first issues, and while there are several embryo queens maturing in the hive. But should unfavourable weather set in about the time for the first leaving, it would be kept back, and may be prevented from issuing till near the time for the young queens coming to maturity. I have known cases where, owing to the prevalence of bad weather, after all preparations had been made for swarming, the young queens have been destroyed, and swarming given up for the time. At all events, we can reckon, as a rule, that the first young queen will not emerge from her cell in less than eight days from the time the first swarm issues. Now if we see that all but one of these embryo queens are removed, that is, all the queen cells but one, and only allow this one to come to maturity, there cannot be any after-swarm, as this queen will be required in the hive. It would not, however, be correct to remove the cells *immediately* after the first swarm leaves, as will be presently shown. The old queen would be laying up to within a very short time of her leaving the hive; consequently there would be eggs in the cells at that time. Supposing the queen cells to be cut out during the first day or two after, the bees would be almost sure to build others, and thus frustrate our plans; but if we let them remain for about five days before we remove them, the larvæ would be too old by that time, and there would be little likelihood of other cells being started. Choice of



a good cell should be made for the one that is to remain in the hive, and the others, if of an excellent strain, may be utilized in forming nuclei. (See Queen-Rearing.)

#### INCREASE BY ARTIFICIAL MEANS.

There are several methods by which increase of colonies may be obtained other than by that of natural swarming, and by which more control is assured, but whichever method is adopted it should be combined with Queen rearing, as this combination is undoubtedly the best for the commercial bee-keeper. I have practised dividing on different lines, all of which have been satisfactory, but I believe the best is that described and carried out by the late E. W. Alexander, the gist of which is included in the following:—

When a colony is in a condition to swarm naturally, remove it from its stand, and put in its place a hive furnished with frames of comb, or foundation. Remove one frame from the centre, and insert a frame of brood *and the queen* from the hive removed in the place of it, taking care there are no occupied queen cells on the comb, if so, destroy them. Place a queen excluder over the frames, and set the original hive with its bees over the excluder. In five days examine the old combs carefully, and if queen cells have been started and are furnished with larvæ, destroy them, unless the strain of bees is good and is worth breeding from, in which case the cells may be retained and the box with the bees may be moved to a new stand. If free of queen cells, or the cells have been destroyed, the box may remain for ten days or so, by which time all the brood will be capped, and things will be well forward in the lower box. The upper box with the bees may then be removed to a new stand and be given in a few hours either a ripe queen cell, or a laying queen, the latter being the best. By this plan no time has been lost, there has been no risk of losing swarms, 100 per cent. increase has been made, and both colonies will be in a flourishing condition.

## CHAPTER XII.

### QUEEN REARING.

#### IMPORTANCE OF REARING QUEENS.

THERE is no branch of commercial bee-keeping deserving of more strict attention on the part of the bee-keeper as a means of improving his bees, than that of queen rearing. It is only in the judicious selection of their breeding stock, season after season, that bee-keepers can hope to make the continuous progress that is possible, and which their interests demand. The improvement of his bees should be the constant aim of each bee-keeper, he should never be satisfied with those he has, but be always striving after a better strain. That it is possible to improve the hive-bee by breeding out inferior characteristics, and breeding in more desirable ones, and so to produce a strain of a higher standard, has been proved over and over again, and no commercial bee-keeper can afford to neglect this part of his business.

#### CHOICE OF BREEDING QUEENS.

The colonies chosen for breeding stock each season should be those that have given the most surplus honey, been the least inclined to swarm after the main honey flow has started, the gentlest bees, and the best defenders of their hives. Any of these qualities lacking at the start should be gradually bred into them. Remember that infinitely better work can be accomplished in the way of improving one's bees by the judicious selection of breeding stock in one's own apiary, than can be done by continually bringing in unknown breeding stock from outside. Even when but

a few colonies are kept as a hobby, the rearing of a few queens will be found a most interesting study.

#### RAISING QUEEN CELLS.

The raising of queen cells is the starting point in queen rearing, and whether the bee-keeper assists the bees in this work by supplying artificial "cell cups," and transferring selected larvæ to them or not, he is dependent upon the bees to bring the young queens to maturity. To ensure this he takes advantage of the natural instinct of the bee, which at once sets about raising another queen when deprived of the reigning one, and in this way he forces the colony by making it queenless to start queen cells.

By supplying it with selected eggs or larvæ, and taking away all others, the bees are compelled to raise queens from these, so that the bee-keeper has almost complete control over their work, and by adopting certain methods he can encourage the bees to build more cells than would be built under natural conditions.

To describe in full the methods adopted by many commercial queen breeders for cell raising, and grafting of larvæ into artificial cell cups, would require too much space, and special books giving full details are obtainable from those who cater for bee-keepers. "Doolittle on Queen Raising," "The Swarthmore Library," and the "A B C and X Y Z of Bee-Culture," being the best. I shall therefore only briefly touch on these methods; and then explain the one most suitable for the average bee-keeper, by which he can be assured of raising the best queens obtainable under any plan.

#### THE DOOLITTLE PLAN.

Mr. G. M. Doolittle, if not the first to make artificial cell cups, was the first to perfect and make commercial use of them. He uses a small, round, smooth stick, pointed to the size and shape of the base of a queen cell. This he dips into melted wax three or four times, the first time about half an inch up the stick, and less

each time, so that the base of the cup is thickest. The cell cups are then placed in wood bases, Fig. 52; A being a cross section of base, and B, the same with cell cup partly inserted.

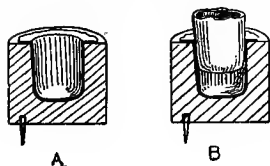

Fig. 52.

CROSS SECTIONS OF  
WOOD BASE WITH  
CELL-CUP.

A portion of "Royal Jelly" from a newly-made natural queen cell is first inserted in each cell cup, and then the selected newly hatched larvæ are transferred to them. The cell-bases with their cups are then spiked to the bars of a frame, see Fig. 53, and the

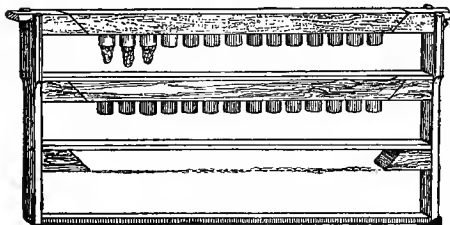

Fig. 53.—CELL-BASES SPIKED TO THE  
BARS OF A FRAME.

frame inserted in a hive containing a colony prepared to receive it, when the work of extending the cells, and caring for the larvæ, is left to the bees. The final treatment of the cells till



Fig. 54.  
A CELL  
COMPLETED  
ON WOOD-  
BASE.

the emerging of the young queens is explained further on. The "Swarthmore" and other methods are exactly similar to the above, slightly modified in the appliances used.

#### THE ALLEY PLAN.

The late Mr. Henry Alley was one of the oldest and most respected commercial queen breeders in the world. His experience extended from about 1860 till his death a few years ago. He worked out a system of queen rearing which is at once

simple, easy to follow, and closely in agreement with the natural method. On his plan, which I strongly advocate, I have raised thousands of far finer queens than I have ever seen bred or been able to raise under other methods.

#### SEASON FOR QUEEN RAISING.

Any time from the commencement of fine, settled weather in the Spring, when drones begin to fly, until the beginning of the Autumn, before the drones are killed off, queens can be reared. In the Auckland Province, and other parts of Australasia in the same latitude, from early in October to beginning of March. The greatest success is achieved just about the time when the bees are ready to swarm in Spring, and early Summer. The largest number of the finest cells will be built at that time.

In order to have the colonies chosen for queen rearing well forward in Spring, and the right drones flying in time, they should be stimulated by slow feeding, and if necessary strengthened by giving a frame of brood occasionally from other colonies. I am, of course, taking it for granted that Italian queens will be bred. As soon as the colonies selected for rearing drones are getting fairly strong, put in near the centre of each of the brood chambers a frame of drone-comb.

#### SECURING DRONE-COMB.

When the bees are in full swing storing honey in the surplus boxes, remove a couple of frames of comb from the centre of the surplus box and insert in their places frames containing a narrow strip of comb foundation. The bees will at once build the frames full of drone-comb, and may store honey in part, and breed in part. They can be removed till the brood dies, and then be given back to the bees to clean. Any quantity of good drone-comb can be secured in this way for future use.

## SECURING SELECTED EGGS.

To return to the drone-combs in the brood chamber. When the first drone brood is sealed over, insert a clean worker-comb in the centre of the brood chamber of the colony set apart for eggs. Combs of the previous season's building that have not been bred in are best

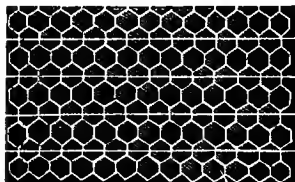

Fig 55.—SHOWING HOW  
TO CUT THE COMB.

for the purpose. On about the fourth or fifth day there will be eggs and probably some tiny larvæ in the comb. If so, remove it to a warm room or workshop and insert another comb in its place. This work should be done on a fine day to avoid getting the eggs or larvæ chilled.

## CUTTING THE COMB.

Lay the frame of comb flat on a table or bench, and with a thin, sharp-bladed knife, cut as much of the comb containing eggs or larvæ in the cells as desired into strips by running the knife (previously wetted with honey diluted with water to keep it from sticking) along every second row of cells, as shown by the white lines in Fig. 55, taking care to leave the intermediate row with the contents intact. The strips will be about one inch deep, but the cells on the side to be used for queen cells should be pared down one-half, and two out of every three eggs or larvæ should be killed, so as to allow room between the queen cells, when built, to cut them out without injury. A tiny splinter of wood, with its end dipped in melted wax, is the best for killing the spare eggs in the cells.

The strips should now be fastened to the under-side of the bars of a frame prepared as in Fig. 56, cells pointing downwards, same as the cell bases in Fig. 53. Or, better still, they may be fastened to the lower edge of a comb, cut in the section of a circle from end bar

to end bar, about one-third down from the top bar. One frame of eggs or larvæ will usually afford strips for two or more frames. The wax used in fastening the strips must not be too hot or it will melt them and destroy the eggs.

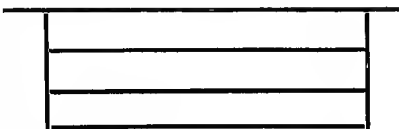

Fig. 56.—FRAME FOR FASTENING THE STRIPS OF COMB TO.

PREPARING A COLONY FOR QUEEN CELL BUILDING.

Select a strong colony—a strong two-story colony with plenty of nurse bees is best—and, first of all, make a nucleus colony with the queen and the frame she is on, and one additional frame of unsealed brood and another of food, with their adhering bees (see instructions for making nuclei). Then remove all frames of unsealed brood without the adhering bees. These, for the time being, may be placed in the top story of another hive containing a strong colony. The frame of strips for queen cells may now be placed in the centre of the brood nest; or the hive may be prepared for them a few hours beforehand. Being deprived of their queen, and having no eggs or larvæ in the hive except those supplied, the bees must build the cells over them. The date and age of the eggs or larvæ should always be marked on the frames, as it will then be known when the young queens will come to maturity. If honey is not coming in freely at this time, the bees should be fed liberally with sugar syrup; there will be more and better cells built by so doing.

RETURNING THE QUEEN AND BROOD.

The Alley system of queen rearing has been objected to by some bee-keepers because they unreasonably supposed that a strong colony must be broken up for each batch of queen cells. This is wrong, for as soon as the queen cells have been sealed (or even before), the frame,

or frames of cells, may be placed in the top box, the queen and brood be returned to the brood chamber, a queen excluder put on over it, and the upper box with the queen cells placed over the excluder. So long as the queen cannot get to the cells, they will be as safe, as a rule, as though she were not in the hive; so that at the most the colony need not be queenless more than four **days**.

#### NUCLEUS HIVES.

I have already in Chapter VI. on Hives, described the small nucleus hives to be used in queen-rearing which should take three or more of the regular Langstroth frames, three are the usual number. Good sized entrances should be made so as to afford ventilation to the interior when wire cloth is tacked over them.

Additional ventilation, which is advisable, may be provided by boring a two-inch hole through the bottom and covering it with wire cloth.

There is a very great advantage in using the same regular frame in the nucleus hives as is used throughout the apiary, and I am satisfied from experience that the economy of bees in caring for queen cells and the young queens until they mate, and are laying, as advocated by some writers at the present time, is entirely against the production of good queens. So far back as 1887 in conjunction with the late Mr. Obed Poole, the inventor of queen excluders, I gave small nucleus boxes, similar to those subsequently advocated by E. L. Pratt ("Swarthmore"), a good trial. Since then I have had experience with small boxes of larger dimensions, but I unhesitatingly advise the adoption of the larger nucleus hives mentioned above, well furnished with bees, if the object is to raise first-class queens.

#### FORMING NUCLEI.

Whatever number of queen cells are to be made use of, the same number of nucleus hives will be required—a piece of perforated zinc or wire cloth should be tacked over each entrance, and there should be some



spare frames of empty combs or foundation at hand. A strong two-story colony will make five nucleus colonies, and leave sufficient bees with the old queen to make another. When the embryo queens are 13 days old from the egg the cells are ready to be given to nuclei.

With the cells and some cell protectors (Fig. 57) ready, select a colony to break up and find the queen, placing her with the frame she is in in an empty hive or comb holder for the time being. Now, put one frame of brood (as much sealed brood as possible) with the adhering bees into a nucleus hive, and another also with adhering bees containing honey and some pollen if possible, and also an empty comb or frame of foundation.

Place a queen cell in protector (Fig. 57) and fasten it on to the centre comb by pushing its projecting end through the comb. Sometimes the bees will tear down the cell, hence the need for protection. All being finished out on the cover and do the rest in same way.

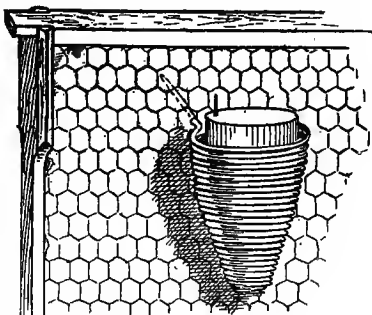

Fig. 57.—QUEEN CELL PROTECTOR.

The bees are now fastened in by the wire cloth over the entrance, and the hives should at once be placed in a cool, dark situation until sunset on the following day, when they may be put in their permanent position and the entrances be opened. Unless the bees are confined for a time the majority would return, and the nucleus hives be deserted. Nucleus hives are best set apart from the main apiary, and from each other.

#### THE EMERGING AND MATING OF YOUNG QUEENS.

The normal time for the young queen to emerge from her cell is on the sixteenth day from the laying of the

egg, but the weather is often the cause for the time varying. If warm and favourable for several days, she may emerge late on the fifteenth day, or through cold weather, be delayed till late on the seventeenth day. When about five days old, if the weather be favourable she takes her "wedding flight" to meet the drone, usually about mid-day. If successful she commences laying in a few days, and is then ready for use in the apiary, but if the nucleus colony, which is now established, is required for other cells later, the queen before removal should be allowed time to stock the combs with eggs.

#### QUEEN NURSERIES.

In queen rearing there are frequently more queen cells coming to maturity than can be made use of at the moment; a nursery in which the spare ones can be placed for the time is very useful in such cases. The Alley Nursery (Fig. 58) is again coming into use, and from a long experience with it I can speak very highly of its usefulness. Similar nursery cages (Fig. 59) may be used for the wood based cells, but the holding frame

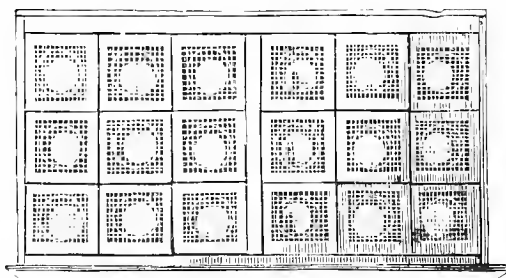

Fig. 58.—ALLEY QUEEN NURSERY.

must be made differently. The cages (Fig. 59) are made out of a smooth batten seven-eighths of an inch thick;  $2\frac{7}{16}$  in. wide, and each cage, being  $2\frac{1}{16}$  in. long, they can be cut off the batten after all are bored. The

large central hole is  $1\frac{1}{2}$  in. in diameter, and the two smaller ones on the edge are  $1\frac{1}{16}$  in., and  $\frac{5}{8}$  in. in diameter and bored through to the central hole; the latter is then covered with wire cloth on each side to make the cage complete.

The queen cell is placed in the larger hole on the edge, and candy food in the smaller one. The frame with cells should be suspended in the centre of an upper story of a hive till the cells are required or the queens emerge. The same cages can be used to introduce the young queens.

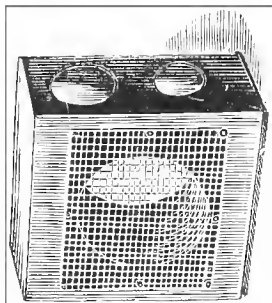

Fig. 59.—NURSERY CAGE.

#### INTRODUCING QUEENS.

As a rule it is not difficult to introduce an alien queen to a colony, be she a virgin or laying, so long as certain rules are observed. The ordinary conditions to ensure safety are—that the colony must first be made queenless, that is, the old queen must be removed. In the next place the new one, when first placed in the hive, should be protected in such a way that while the bees can see and even feel her with their antennæ, they are prevented from stinging her, as they might do before becoming used to her. And lastly, the colony should be fed if there is no honey being gathered while the queen is being introduced. There are exceptions to the second clause. In the busy season, when honey is coming in rapidly, if the queens can be changed without much disturbance of the hive, the new one is likely to be accepted just as readily if she is turned loose on the frames as she would be were she protected for a day or two. I have often introduced them in this manner with success. On the other hand, I have had great difficulty with some colonies when trying to get them to accept a queen when introduced in the usual way.

## INTRODUCING CAGES.

There are several kinds of introducing cages, but I think the two shown in Figs. 60 and 61 are about the handiest of any.

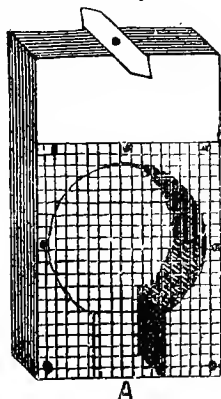

Fig. 60.—ALLEY'S  
INTRODUCING CAGE.

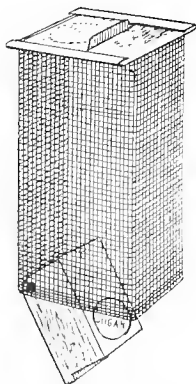

Fig. 61.—TITOFF  
INTRODUCING CAGE.

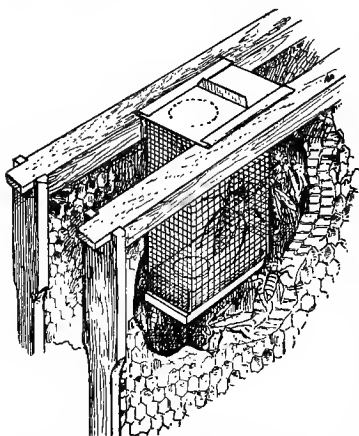

Fig. 62.—SHOWING INTRODUCING  
CAGE IN USE.

Place the queen to be introduced with as little handling as possible and *without any bees*; and plug up the entrance to cage with candy. After the queen you are superseding, together with queen cells (if any) have been removed, hang the cage from the top bars between two of the centre frames (as in Fig. 62) and pressed against some honey so the queen can feed herself. Close down

the hive and don't disturb it again for three or four days, long before which she will probably have been released, when the cage can be removed.

#### CANDY.

I have spoken of Candy for use in the queen nursery and introducing cages; the following is the best way of making it. Crush up some loaf sugar very fine; if a good deal of candy is needed, as when commercial queen rearing, a good coffee mill is best for this work. The sugar should be like flour; beware of buying ground sugar, as there is frequently starch or some foreign matter mixed with it that is death to bees. Warm some honey, but be sure it comes from a clean hive, and mix a little (it requires very little) with the ground sugar. Knead it well and add more sugar until the ball becomes firm but moist; when the ball of candy is left on a board for 24 hours it should only flatten out a little, it is then right. It will do for nursery, introducing and shipping cages.

#### DRONE TRAPS.

When queen rearing, if there be any undesirable drones flying in the apiary they may be trapped and destroyed by placing drone traps (Fig. 63) in front of the hives containing them. Some also use them for

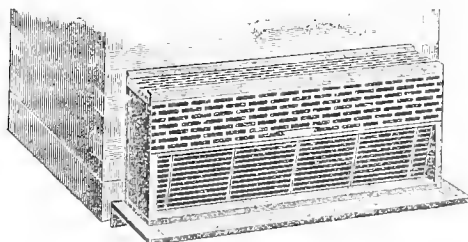

Fig. 63.—DRONE AND QUEEN TRAP.

trapping queens at swarming time, I have never used them for this purpose, so cannot speak of their usefulness or otherwise in this respect. No apiary should be without a few of them.

## ITALIANISING AN APIARY.

I have already advised beginners for the sake of economy to start with black bees, and as soon as the apiary is fairly established to Italianise all the colonies. If you have decided to try your hand at queen rearing, then purchase, say, three tested, or select tested, Italian queens from a reliable breeder as early as you can get them in the season, or at any time during the swarming season will do. Introduce them to strong colonies and follow the instructions herein given for rearing queens. If, on the other hand, you prefer to purchase all the queens at first to Italianise your stocks, then order, say, two tested and the rest untested queens, and after you have Italian drones flying in fairly large numbers start queen rearing with eggs from your tested queens, and so gradually change the untested queens that turn out to have been mismated to purely mated ones of your own raising, unless you are not particular about having a few hybrid colonies in your apiary.

## CLIPPING QUEEN'S WINGS.

The chief object in clipping the queen's wings is to prevent swarms absconding. Much has been said for and against the practice, but it has been largely adopted of late.

## HOW TO CLIP.

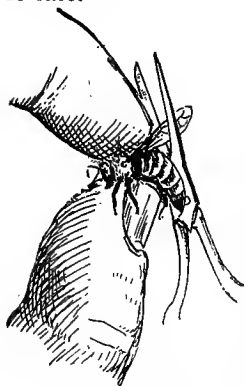

Fig. 64.—CLIPPING WINGS.

When clipping, the queen should be held as in Fig. 64, by the abdomen, while the two wings on one side only are clipped off near the stumps.

On the other hand, if the bee-keeper is not at hand when the swarm issues, the queen, not being able to fly, may get lost by falling on the ground, and so being unable to reach her hive again. A tin fence,  $1\frac{1}{2}$  in. wide, tacked round the alighting board, and having the upper half-

bent inward, would prevent the clipped queen from falling to the ground, and so enable her to return to her hive.

In every case when a queen is purchased the wing should be clipped to prevent subsequent misunderstanding. It sometimes happens that a short time after a queen has been accepted the bees for some reason will supersede her, raising another queen from her eggs, the young one not being distinguishable from her mother. If the new queen should get cross-mated her bees will be hybrids, and the bee-keeper, not knowing the queen he introduced has been superseded, naturally accuses the bee-breeder of fraud in sending him a cross-mated instead of a pure queen. Now, by clipping the wing it can be seen at once if the original still reigns.

#### SUPERSEDING QUEENS.

The supersedure of queens after they are past their prime or in some other way have become defective, may be done by the bees, by installing another and younger one in her place. It is now the practice however, among the majority of experienced commercial bee-keepers, to carry out a system of superseding themselves, and not trust to the bees to do it, as they believe in the latter case that queens are frequently kept till long after they have passed their profitable age. The consensus of opinion is in favour of supersedure at or near the close of a queen's second season, and I feel certain that (with few exceptions), owing to the genial winter temperature of Australasia, and the prolonged breeding season, queens are at their best in this part of the world in their second season, and rapidly deteriorate after. I therefore recommend the replacing of queens not later than February of the second season, excepting, of course, in very special cases, where a queen may have exceptionally good qualities, as reflected by her bees.

#### SWARMING CELLS.

Some bee-keepers object to making use of spare queen cells from a colony that has just swarmed, on the

grounds that they are likely to produce queens whose bees would have an abnormal propensity to swarm. This, in my opinion is poor reasoning; they apparently overlook the fact that to swarm is natural in all strains of hive bees. Their apprehension could only correctly apply to strains which already are prone to swarm, and from which no sensible apiarist would breed in any case. There certainly can be no reasonable objection to making use of spare swarm cells from a good strain of bees, using the same discretion in choosing them that one should do in queen rearing. Such cells from a strong colony produce the very finest of queens.

#### WOOD BASES FOR QUEEN CELLS.

There is no doubt that the wood bases to cells as described, are a very great convenience, and it has occurred to me that some such bases might be attached to the queen cells built on the Alley plan. If shallow holes were bored into similar pieces of wood as is used in the Doolittle plan, the Alley cells when built might be glued to them with melted wax; at all events, it is worth trying.

#### FEEDING IN QUEEN REARING.

Though I have already mentioned this matter, I wish to impress upon all who undertake queen rearing for the first time, the importance of feeding in all stages of queen rearing when no honey is being gathered, and the same applies especially when introducing queens. I shall give the formula for making sugar syrup later on.

#### ANOTHER METHOD OF RAISING CELLS.

The method I am about to describe was, I believe, first tried and described by an Austrian bee-keeper, but so far as I am aware, I was the first to give it a trial in



this part of the world at the Government Apiary, and with excellent results as Fig. 66 indicates.

A new bright (wired) comb of the previous season's construction was put into the hive of one of our breeding queens; when fairly full of eggs and newly hatched larvæ it was removed and laid flat on a bench. A thin-bladed knife was run along each side of every fourth row of cells, cutting down to the mid-rib only. The three intermediate rows of cells were scooped out with the blade of a broad bradawl, as shown in Fig. 65, an easy matter, leaving every fourth row intact. Two out of

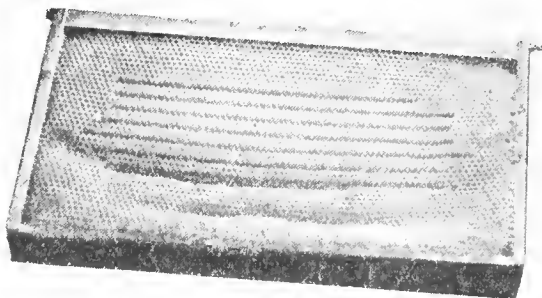

Fig. 65.--COMB PREPARED FOR QUEEN CELLS.

every three eggs or larvæ in the standing rows were killed, as in the Alley plan, and also all eggs and larvæ between the rows. This is important. The cells on the opposite side of the comb were not touched.

A strong two-story colony was in the meantime prepared for cell building in the manner already described, an empty half-story was placed immediately over the brood chamber, an empty frame being laid flat on the brood frames, and the prepared comb (prepared side downwards) laid flat on the empty frame. The latter was covered with a light mat, and the upper story replaced.

In due course we obtained sixty good cells in our first experiment, and over eighty as shown in Fig. 66 in our



Fig. 66.—COMB OF 80 GOOD CELLS.

second trial. The above illustrations were made from photos taken by myself, the cells being fore-shortened in the view, look smaller than they really were. As soon as the cells are well started a queen excluder may be put on and the queen returned in the manner previously described.

#### CAUTION.

The comb lying flat over the brood chamber is subject to considerable heat, and we found in one case part of the comb had sagged down owing to the softening of the comb, and weight of the bees. We then wound wire around the frames between the standing rows of cells, which checked the sagging. Either wire or thin splints of wood will do. We obtained some very fine queens by this method, and as a wholesale way of raising cells, I consider it immensely superior to raising them on the swarm box plan with a small force of bees from artificial cell cups and transferred larvæ. Plenty of ventilation should be provided when raising queen cells in this manner.

## CHAPTER XIII.

### SURPLUS HONEY.

#### SPRING MANAGEMENT.

IN the latitude of Auckland, and for some distance South, the breeding season starts about the last week in July, and the hives should be overhauled in suitable weather early in August. Colonies with good queens will have patches of sealed brood in the centre combs by the second week in that month. Any that are broodless, or nearly broodless, at this time should be marked, to be examined again a little later, and be united with others if there is no improvement.

#### TOP BOXES.

All top boxes that have been left on through the winter should now be removed, and the bees be confined to the brood chambers. In the event of the bees having taken to the top box, remove the lower one, and set the former down in its place, after scraping the bottom board. See that there is sufficient food in the hive, and cover the frames snugly with two or three well-fitting mats.

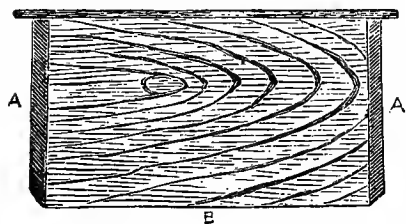

Fig. 67.—DIVISION BOARD.

#### CONTRACTING HIVE SPACE.

It is necessary to conserve the natural warmth of the bees at this time in order that breeding may proceed uninterruptedly, there-

fore, when a colony does not cover more than three or four frames the hive should be contracted to that space with division boards (Fig. 67) in the manner shown in Fig. 68. They can be purchased or be readily made out of an inch board, 9 in. wide, cut into lengths that will fit the hive lengthwise as in Fig. 67.

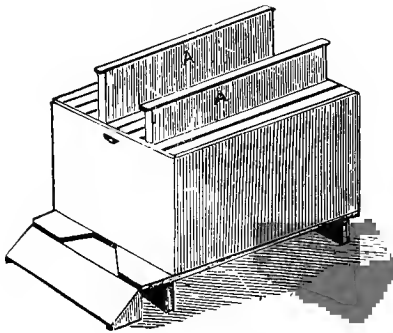

Fig. 68.

SHOWING DIVISION BOARDS IN USE.

If the ends are bevelled a little as at A, A, in Fig. 66, they can be made to fit better, and be more readily fixed in place. As the gradual enlargement of the colony demands it, the division boards should be moved from time to time till they can be dispensed with altogether.

#### SPRING FEEDING.

The chief contributing factors to successful spring management are warmth, and an ample supply of food in the hive; when these are present breeding will go on satisfactorily, but without either one it cannot. The former can readily be obtained in the manner described, but the latter is frequently neglected, either through oversight or carelessness. My position as Government Apiarist gave me many opportunities of observing this, and was the cause of my drawing attention to it in my Government Bulletin, as follows:—

“Next in magnitude to the losses of bees which result from inattention to disease are those which occur in the spring months through starvation. Few but experienced bee-keepers and those who have suffered financially from losses realise how readily the food-supply may become exhausted after breeding is in full swing in spring. In my

rounds hitherto I have found it a general complaint that numbers of colonies have died off in the spring. The owners did not know the cause, and when starvation was suggested they were quite surprised, as they 'had left plenty of food in the hive the previous season,' and it had never occurred to them that the supply might run short. All bee-keepers worthy of the name will take care that their bees never run short of food, be it spring, summer, autumn, or winter.

Given a fair supply of stores in late autumn, when fixing the bees up for winter, a colony will use comparatively little during the winter months, but as soon as breeding begins in the latter part of July or early August the stores are largely drawn upon for feeding the brood, and unless nectar can be gathered to help them out, the stores will rapidly diminish. As a rule willows and other spring forage afford a good supply in fine weather, but the weather is frequently far from fine at that time—generally unsettled, and against the bees securing nectar. Take a case, for example, where the bees have come out of winter quarters with a fair supply of food in the hive, the weather fine, and some nectar is being brought in from the fields. Under these conditions, where there is a good queen, breeding will go ahead very rapidly, and in a short time there will be a big lot of brood to feed, and a large quantity of food needed. If at this time bad weather should set in and last for several days, preventing the bees gathering nectar, probably within a week pretty nearly all the reserve stores within the hive will be used up, and if the bees are not seen to before they arrive at this stage they will probably die of starvation. This is not a fancifully drawn case, but a real practical one, and shows just how such large losses occur in spring."

#### STIMULATIVE FEEDING.

This is simply feeding to force brood rearing, as in the example already given in queen rearing where colonies are to be forced on ahead of the others in the apiary, and is quite independent of the quantity of food in the hive. So long as the bees are storing a little more food than they are using, no matter from what source it comes, they will be stimulated into extra brood rearing.

Sugar syrup made in the following manner is the safest and best food. Mix half a pint of water with each pound of sugar, stir well, and bring to the boil. When cool, it is ready for use. Never feed honey

unless you are absolutely certain it came from a clean hive, and use cane, not beet, sugar.

#### FEEDERS.

There are several kinds of feeders advertised by those who cater for bee-keepers. Clean, empty combs make excellent feeders, and they can be filled by placing them on an inclined board in a large milk dish or other similar vessel, and pouring the syrup through a fine strainer held a foot or so above them. The force of the falling syrup expels the air from the cells, and the syrup takes its place. After filling, the combs should be suspended over a vessel (to catch the drip) before placing them in the hives.

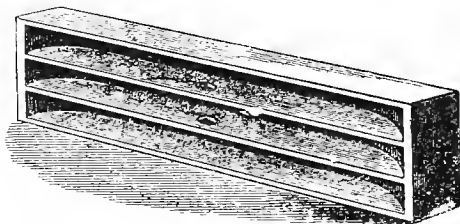

Fig. 69.—“ SIMPLICITY ” FEEDER.

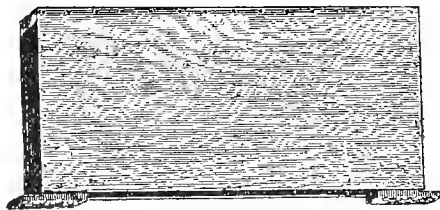

Fig. 70.—“ DOOLITTLE ” FEEDER.

The “Simplicity” feeder is an excellent one to stand on the frames under the cover. Then there is the “Doolittle” division board feeder (Fig. 70) to suspend

in the hive. Also the large "Miller" and "Alexander" feeders, all of which are to be obtained from hive manufacturers. Always give food and replenish the feeders in the evening.

#### UNITING.

All colonies making little or no headway in breeding, denoting poor queens, and any that are found to be queenless, should be united with others that are more prosperous; as early in the spring as possible. There will only be loss in trying to nurse colonies with poor queens with the hope that they will improve later on; better to make use of the bees at once. I have of late united colonies in the following manner with the greatest success. Place a queen excluder over the frames of the colony the other is to be united to, and put the body of hive containing the latter as a top box over the excluder after killing the queen. In no case have I had trouble with fighting, but it is well to watch the hive for a few hours, and if anything occurs give a good dose or two of smoke. In two days the excluder can be removed.

#### SURPLUS HONEY SUPERS.

(EXTRACTED HONEY.)

When a colony is getting fairly strong, with plenty of sealed brood in the hive, and honey coming in, a top box or super should be put on. Care must be taken that this is done before preparations for swarming are being made by building queen cells. On the other hand, it should not be put on too soon, as the extra space for cold air would do harm.

When working for extracted honey, the two side combs from the lower hive, with the adhering bees, should be placed in the centre of the lower one. As the season advances, there will be more and more bees working in the super storing honey, and probably the queen will lay in two or three of the upper combs. This brings me to the use of queen excluders.

## QUEEN EXCLUDER HONEY BOARDS.

“Queen Excluders,” as they are usually called, are made of perforated zinc, Fig. 71, and also slats of thin wood and wire, Fig. 72. Both have spaces through which worker bees can pass, but queens and drones cannot. They are very useful in queen rearing, and in uniting colonies; but for the purpose they are generally used, viz., for confining the queen to the

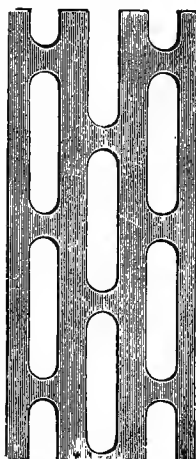

Fig. 71.  
ZINC EXCLUDER.

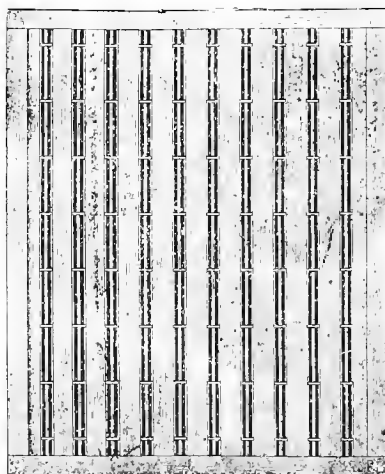

Fig. 72.  
WOOD AND WIRE EXTENDER.

lower hive through the honey season, I have no hesitation in condemning them. As I have gone into this question fully on a previous occasion, I will quote my remarks:—

“The most important point to observe during the honey season in working to secure a maximum crop of honey is to keep down swarming, and the main factors to this end, as I have previously stated, are ample ventilation of the hives, and adequate working-room for the bees. When either or both these conditions are absent, swarming is bound to take



place. The free ventilation of a hive containing a strong colony is not so easily secured in the height of the honey season, even under the best conditions, that we can afford to take liberties with it; and when the ventilating-space between the lower and upper boxes is more than half cut off by a queen-excluder, the interior becomes almost unbearable on hot days. The results under such circumstances are that a very large force of bees that should be out working are employed fanning, both inside and out, and often a considerable part of the colony will be hanging outside the hive in enforced idleness until it is ready to swarm.

Another evil caused by queen-excluders, and tending to the same end—swarming—is that during a brisk honey-flow the bees will not readily travel through them to deposit their loads of surplus honey in the supers, but do store large quantities in the breeding-combs, and thus block the breeding-space. This is bad enough at any time, but the evil is accentuated when it occurs in the latter part of the season. A good queen gets the credit of laying from two to three thousand eggs per day: supposing she is blocked for a few days, and loses the opportunity of laying, say, from fifteen hundred to two thousand eggs each day, the colony would quickly dwindle down, especially as the average life of the bee in the honey season is only about six weeks.

For my part I care not where the queen lays—the more bees the more honey. If she lays in some of the super combs it can be readily rectified now and again by putting the brood below, and side combs of honey from the lower box above; some of the emerging brood also may be placed at the side of the upper box to give plenty of room below. I have seen excluders on in the latter part of the season, the queens idle for want of room, and very little brood in the hives, just at a time when it is of very great importance that there should be plenty of young bees emerging."

#### ADDITIONAL TOP BOXES.

When the main honey flow has fairly set in and the colonies are in good condition, one surplus honey super, as a rule, will not be sufficient to work the hives to the best advantage. A second one should be put on before the first becomes overcrowded, and before queen cells are started. While doing this see that any frames of brood or eggs above are shifted below, and all combs devoid of brood below are placed above. When putting on extra supers. always set them immediately

over the brood chamber, and under the others already on. This tends towards keeping the former from getting overheated, and the bees will always work downwards when they will not work up. I think it almost impossible to work a strong colony to the best advantage with less than two top boxes, and I often use three when there is a good flow of nectar on.

#### EXTRACTING.

When working on the system of allowing the honey to be capped over before extracting it, or in other words, letting it ripen in the hive, care must be taken that plenty of working room is provided for, especially during a strong flow of nectar, or swarming will result. At such times honey will be stored faster than it can ripen and be capped over, so that it is necessary to increase the working-room by adding top boxes until some of the combs are ready for the extractor, which should be kept at work on every opportunity.

#### COMB BASKET AND BRUSH.

When removing surplus honey from the hives it is necessary to have something to place the frames or

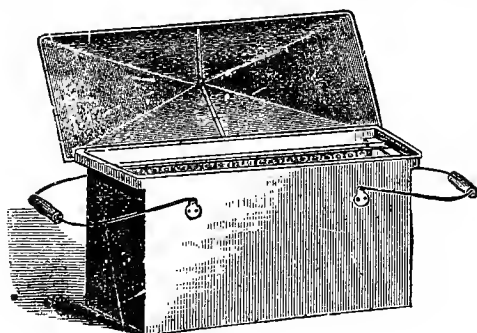

Fig. 73.—COMB BASKET.

sections in, both for convenience of carrying and to keep the honey secure from the bees until it is safe in the honey or extracting house. Tin comb-baskets, similar to the one shown in Fig. 73, answer the purpose admirably. They are light, strong, clean, and handy. They should be made so that the frames will hang in them the same as in a hive, and should have a space of at least two inches below the bottoms of the frames, to hold any honey that may drip from the combs after they have been uncapped. To hold six frames conveniently they should be at least 8in. wide inside.

Another indispensable appliance is a brush of some kind for brushing the bees off the combs when removing them from the hives, and the kind shown in Fig. 74 is about the best for the purpose.

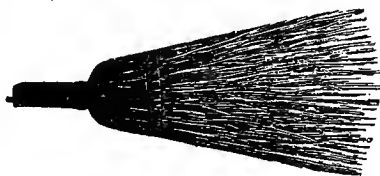

Fig. 74.—BEE BRUSH.

This is a sort of whisk broom especially made for brushing bees. The strands are thinned out and are longer than ordinary hand brooms so as to afford a soft, pliable, easy sweep of the combs.

#### THE "DAISY" BARROW.

A light running barrow of some kind is an absolute necessity in the apiary for carrying hives and other appliances to and fro, and to serve as a platform

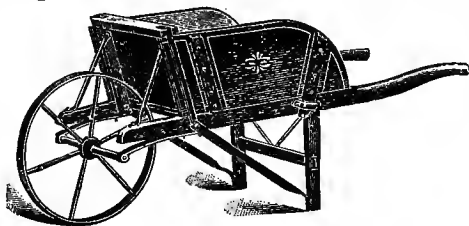

Fig. 75.—THE "DAISY" BARROW.

for placing surplus boxes on when manipulating a hive. There are barrows of different designs, but the one illustrated I have found to be very useful and handy. They are supplied by hive manufacturers.

#### NUMBERING THE FRAMES OF EACH HIVE.

In an apiary perfectly free from disease no heed need be taken as to how the combs are changed about from one hive to another, and at extracting time the combs taken from one hive as soon as emptied may be given in place of those taken from the next. Not so, however, where there is any taint of disease, as no surer way of spreading it could be adopted than to promiscuously change the combs. In this case every frame should bear the number of the hive it belongs to, and be returned to it, and all the combs from suspected hives should be the last extracted, when they can be kept by themselves.

#### RIPENING EXTRACTED HONEY.

The thorough ripening of honey before placing it on the market is a matter of the greatest importance, both to the owner and to the industry generally. When first gathered as nectar, it may contain an amount of water ranging from 18 per cent., up to 25 per cent., or more. Honey containing an excess of moisture is unripe, and if it remain in that condition it is certain sooner or later to ferment; it is then unfit for table use. But, if such moisture be reduced below a certain percentage the honey is said to be ripe, and it will then keep, with ordinary care, for almost any length of time. At what point the excess of moisture commences I have not yet been able to ascertain, nor, so far as I am aware, has it ever been decided by analysts or sugar experts. It is beyond the accomplishment of the average beekeeper to determine by evaporation the amount of moisture in a given sample of honey; but by close observation of the specific gravity of the class of honey he raises, he will in a short time have a serviceable guide as to its fitness for market at any time.

During my term as Government Apiarist I tested over 100 samples of different grades of honey (see Bulletin No. 18 on Bee-Culture), by the hydrometer, in order, if possible, to formulate a standard specific gravity for ripe honey of different varieties. Though I had not completed my investigations, the tests made of clover honey, which constituted more than three-fourths of them, lead me to believe that any of this class showing a density of 1.420 or over is fit for market. Though I cannot speak so positively of other varieties, I have little doubt that a similar density would denote a fair degree of ripeness. It must be understood that in speaking of "clover honey," I mean that the bulk of a given sample had been gathered from white clover blossoms, of which fortunately we can raise plenty in New Zealand.

#### RIPENING HONEY INSIDE AND OUTSIDE THE HIVE.

Little need be said with regard to ripening honey inside the hive, as the capping or sealing of the honey cells is generally understood to indicate that the contents are ripe. Some bee-keepers, however, consider it necessary to leave the honey in the hive for some little time after it is capped to be certain of it being thoroughly ripened. I know a few who leave all the surplus honey on the hives till the last of the season, which, in my opinion, is unnecessary and a very wasteful way of working an apiary.

With regard to extracting honey from combs partly capped and finishing the ripening outside the hive, I maintain in the absence of chemical proof to the contrary, and so far as the palate can detect, that equally as good honey for marketing purposes can be produced in this manner as in the more costly method of ripening within the hive.

#### RIPENING HONEY OUTSIDE THE HIVE.

My experience in this matter goes back to the season of 1883-1884, when my first experiment was with ten

tons of clover honey, and it was so successful that I have continued the method since, both as a private bee-keeper and as Director of the New Zealand Government Apiaries with equal success.

As I have already pointed out, during a heavy flow of honey, when it is left in the hive to ripen it is necessary to keep adding top boxes to take advantage of the flow, as the honey will be stored faster than it can be ripened. This means the providing of a large quantity of extra material and combs at considerable cost. Each top box would be worth at least 2s. 6d., and the nine frames of comb at 1s. 3d. each, 11s. 3d., making a total of 13s. 9d.; and two of these extra boxes may sometimes be needed for each hive if full advantage is to be taken of the conditions mentioned.

#### RIPENING AND MATURING TANKS.

The most effective method of ripening and maturing honey is to expose a large surface of comparatively shallow mass to a warm, dry, atmosphere. Even when the honey is allowed to ripen within the hive it is necessary to have shallow tanks to mature or clarify it, for, no matter how small in the mesh the strainer may be or how carefully the honey is strained, it is impossible to prevent very fine particles of wax and pollen-grains running from the extractor into the tank with the honey. If the body of the honey is deep these particles cannot rise to the surface as they do in a shallow tank, forming a scum, which, when skimmed off, leaves the honey in the very best form for market. Air-bubbles, which in themselves may contain moisture (and it is absolutely certain that honey containing air-bubbles quickly deteriorates), cannot rise or escape through a deep mass of honey.

The tank shown in Fig. 76 is, as indicated, 6 ft. long, 4 ft. wide in the two compartments, and 20 in. deep, outside measurements; and calculated to hold about 1,250 lbs. of honey in each compartment. It represents those in use at the Government Apiaries, which are made of  $1\frac{1}{4}$  in. timber, and lined with stout

tin. Of course, each bee-keeper will decide for himself as to the size of his tanks, but the depth should be limited to from 20 to 24 in. at most.

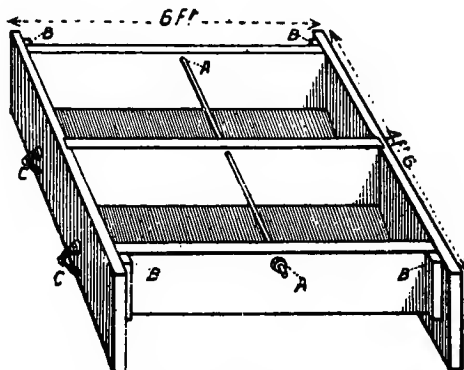

Fig. 76.—HONEY TANK.  
(Not drawn to scale.)

For an apiary of, say, two hundred colonies, two such tanks as the double tank illustrated would in most cases answer the purpose. There is a great advantage in dividing the tanks into compartments, so that the honey from each day's extracting may be left undisturbed until it has matured and is ready to run into tins. It is unwise to run two or three days' extracting into the same tank, as the frequent disturbance is against the honey maturing properly.

#### HONEY-STRAINERS.

The strainer in use at the State Apiaries consists of a long shallow tin box without a cover, and with one-half the bottom formed of fine wire gauze, and the other half of tin. This box reaches right across the double tank, and by turning it end for end the honey can be run into either division. Inside the box two other loose strainers slip, the upper one is a coarse

strainer to catch dead bees, large pieces of wax, &c. and the under one finer. These can be taken out and cleaned when required.

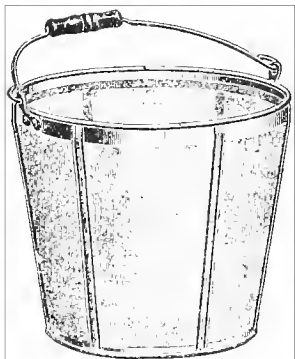

Fig. 77.

ALEXANDER STRAINER.

A good plan, if the contour of the ground will allow of it, is to arrange the honey-tank at a level 3 ft. or so below the extractor and strainer, so that the honey, after passing through very fine meshes and thus being split up into fine threads, shall fall that distance before reaching the tank. The atmosphere, being warm and dry, will absorb very much of the moisture in the honey in its descent.

The late E. W. Alexander introduced the strainer shown in Fig. 77, which is in the form of a bucket, the sides, and bottom, being made of fine wire gauze, 50 meshes to the inch. They are obtainable from hive manufacturers.

#### LIQUEFYING GRANULATED HONEY.

I wish to caution bee-keepers against overheating when liquefying granulated honey. The usual advice given is that it may be heated up to 160° Fahr. without doing harm to the honey. From close observation I am satisfied that much of the fine aroma and flavour characteristic of our best honey is lost when slowly heated up to anything near that temperature. To avoid injury the honey should not be heated many degrees above the normal temperature of the hive in summer—say, about 110°. I am fully aware that granulated honey will take a long time to liquefy at that temperature, but better that than injure it,



## WORKING FOR COMB HONEY.

The same method is pursued right up to the time of putting on the top as when working for extracted honey, but instead of using full depth supers, half-stories furnished with one pound sections, as explained in a previous chapter should be employed. Beginners frequently complain of the difficulty in getting bees to start work in the sections in the spring. This unwillingness to enter the sections boxes in the early season on the part of the bees, is readily explained. The bees cannot build out comb until there is a fairly high temperature to enable them to secrete and manipulate the wax. About the time the top boxes are put on the weather is frequently very changeable with cold nights, and entirely against wax working, especially when the bees are necessarily split up into small clusters as they must be in section boxes. The weather must be settled and fairly warm before the work can commence.

## “ BAIT ” SECTIONS.

“ Bait ” sections are partly worked sections held over from the previous season, and are very useful for placing in the centre of the first boxes put on. No doubt they afford some enticement to the bees to start work in the sections a little earlier than they would otherwise ; in any case the frames should be covered snugly with mats to retain the heat of the hive.

After the bees get fairly started in the first top box, place the second half-story underneath, and take care to remove the sections as they are finished without waiting for the whole of them to be ready for removal, and replace them with empty sections. Remember that it is more difficult to keep down swarming when working for comb, than when running the hives for extracted honey. Give ample working room immediately above the brood chamber, and plenty of ventilation from below.

See that the whole of the cells are capped over before removing the sections, and when they have been removed, scrape the boxes free from propolis, and allow

them to remain in the store-room for a few days before crating them for market. Use small crates holding not more than two dozen. Excepting beginners, and those located where the honey gathered is too dense to extract, I would advise the raising of extracted in preference to comb honey.

#### AXIOM.

“ IN DISTRICTS WHERE FORAGE IS ABUNDANT ONLY FOR A SHORT PERIOD, THE LARGEST YIELD OF HONEY WILL BE SECURED BY A VERY MODERATE INCREASE OF STOCKS ”

*Langstroth.*

## CHAPTER XIV.

### AUTUMN AND WINTER MANAGEMENT.

The closing of the surplus honey season varies as to date according to latitude and the particular kind of flora available. As bee-keeping is carried on in Australasia over an extent of nearly 30 degrees of latitude, it is next to impossible to give even an approximate date suitable for all parts. In most parts of New Zealand, and the Southern districts of Australia, the season as a rule closes in the latter half of February, though in some years it extends into March. So far as my observations go, the earlier the season commences the earlier it ends, and *vice versa*, this I have found to be the rule. The Autumn flow of nectar in New Zealand is usually sufficient to keep up breeding and to afford at least some winter stores.

### TAKING THE LAST SURPLUS HONEY.

The novice may readily gauge the near approach of the end of the season by the killing off of the drones, and the inactivity of the field bees in the afternoons. The last of the surplus honey, whether comb or extracted, should always, as far as possible, be taken before the season has entirely closed to avoid trouble with robber bees, which are very active at this time. I know this is sometimes neglected with the result of loss to the owner.

With regard to section honey, it is important to know how to avoid having a lot of partly finished unmarketable sections at the end of the season. A month or so before the usual time for the close of the season, collect all the very backward sections, and give them to the strongest colonies in the apiary, and put those nearly finished on the others. By working them in this manner there will

be very few, if any, to hold over ; should there be a few they will do for " bait " sections the following spring.

#### BEE ESCAPES.

Those known as the " Porter " bee escapes, Fig. 78, are most useful appliances at times, especially when robbers are about, as by their aid supers may be automatically emptied of bees without any trouble whatever. They are very useful at all times to those keeping a few colonies as a hobby, as the surplus honey may be removed with little or no risk of being stung.



Fig. 78—PORTER  
BEE ESCAPE.

If the removal of the last of the surplus honey has been delayed, robbers may be avoided by the use of escapes. The escape shown is made of tin, and this is let into a board the size of the top of a hive; when to be used, the super with bees is raised up, and the escape board with the round hole of the escape uppermost, is placed underneath, using no more smoke during the operation than is necessary.

If put on in the late afternoon, and there is no brood or queen in the super, the bees will be all cleared out by the morning—a few young wax workers may remain but will give no trouble.

Care should be taken to see that the board fits well so that the bees after passing through the escape cannot return ; it is impossible for them to return through the escape. If put on during the day, shade the hive from the hot sun by laying a folded sack over the cover, and give plenty of ventilation from below.

#### AUTUMN BREEDING.

This is, as I have already intimated under " Spring Management," a most important consideration in the

autumn management of the apiary. On having plenty of young bees in the hives when fixing the colonies up for the winter, depends the success of the apiary in spring, and to ensure this breeding must be kept up till late autumn. Young robust queens and plenty of food are the two principal factors in this matter. Queens past their prime cease breeding very soon after the end of the honey season, independent of the quantity of food in the hives. Where no attention has been paid to the superseding of aged queens, some will be found in the apiary that have ceased breeding in March, while others keep on till well into May. Those that cease breeding early almost invariably die during the winter, or early the following spring, which, in either case, means the loss of their colonies. February, as I have previously stated, is, I consider, the best month for superseding queens.

#### UNITING.

No attempt should be made to carry weak colonies through the winter except by experienced apiarists, and only then when there is some special object in view, as they always constitute a danger by affording opportunities for robbers. It is best to unite them with others in the manner given under "Spring Management," and the earlier in the autumn it is done the better.

#### ROBBING.

Immediately after the close of the main part of the honey season when the bulk of the field bees are practically idle is the time to beware of robbing, and the less the hives are opened then the better. If it is necessary to open any, it should be done as early in the forenoon as possible, as there are more robbers about after mid-day. Robbers dart into a hive as soon as it is opened, therefore the work should be got through as rapidly as one can do it. They may be dodged a bit by quickly changing from one part of the apiary to another the farthest away, but they soon follow up. Robbing never occurs while there is sufficient nectar to be gathered to

keep the field bees busy ; it is only during a dearth, and at the close of the season that it takes place if there is the slightest opportunity afforded. It may of course occur in winter or spring, but there is not so much risk at these times. Ordinary precautions, however, should be observed at all times.

Robber bees " on the prowl " may be seen examining the joints of the bottom boards, supers, and covers, and dodging about on the wing in front of the hives, every now and again making a feint to alight near the entrance, but quickly dodging back again on the approach of a " sentinel." Hives containing small colonies should have their entrances contracted a little while robbers are about.

#### PRECAUTIONS.

The first six weeks after the end of the season is the worst for robbing. No saccharine matter of any kind should be left where bees can get at it, and the honey house should be kept clear of bees at this time. The advantage of having a bee-tight honey house will then be appreciated. Robbing may easily be prevented, but when once it gets in full swing it requires all one's ingenuity to stop it, and an apiary may be ruined before it can be mastered. The bees at such times become demoralised, and will sting any animal that approaches within a hundred yards of the apiary.

#### TO STOP ROBBING.

It is easy to detect open robbing, but there is sometimes a quiet tranquil kind of robbing going on without the violence associated with the former, but which is nevertheless quite as dangerous, and more difficult to detect. It occurs chiefly in the colder weather of early winter and early spring. At first there is nothing abnormal about the hive to be seen, the bees seem to be going in and out as usual, but an experienced apiarist might notice that the bees are rather more active than those in the other hives. Later on, minute portions of

wax will be seen at the entrance, which is really portions of the cappings of the honey cells. By this time, the condition of the robbed colony is hopeless; it will be queenless, the queen probably having been killed, and all the honey robbed out, when the best that can be done if there are a good few bees still in the hive is to put it over a queen excluder on another hive.

At the beginning of the attack, a wet cloth, or bunch of wet grass laid across the entrance, and a douch of water from a watering pot through a fine rose held breast high in front of the hive, so as to sprinkle the bees flying near the entrance will usually stop a mild case. The cloth or grass should be removed occasionally to allow bees to come out but none to go in. A rag sprinkled with kerosene, or carbolic acid, hung over the entrance is said to be effective, but when a hive is severely attacked it is best to remove it away altogether, and to watch the adjoining hives closely for a while. The robbed hive may also change places with an extra strong colony, which will be effective.

#### PREPARING FOR WINTER.

It almost seems out of place to speak of preparing for winter in connection with bee culture in Australasia, where the average temperature and climate suggests perpetual summer when compared with the severe winters of some of the chief bee-keeping countries of the Northern Hemisphere. There is, however, a short period of about three months, when in the Southern parts breeding ceases, and it is advisable during that time not to meddle with the hives at all unless something unusual occurs.

#### WINTER FOOD SUPPLY.

Early in May is the most suitable time for finally fixing up the bees for winter. The bees should have been breeding up to about this time to ensure a large number of young bees going into winter quarters. Go through each hive and note the food supply; about 30 lbs.

is a fair quantity for winter and early spring stores. The honey will be distributed through a number of frames, but by calculating on the basis that a frame when fairly full will contain about 6lbs.; it will be easy to estimate the total quantity. It is best to feed earlier in the autumn if there is any risk of a shortage of a winter supply.

#### SPARE TOP BOXES.

All top boxes not previously removed and that are not at this time occupied by bees should be taken off. My own experience has been that colonies in real good condition are strong enough in May to need one deep super on the brood chamber, and so long as the frames are well covered with mats I have found them winter all right in this way, until the bees are reduced in number sufficiently to be all located in the brood chamber.

#### EXTRA MATS AND COVERS.

A good supply of extra mats should be on hand during the winter to take the place of any that may get damp. An occasional inspection of the mats should be made, especially after a spell of wet weather. A few spare covers are always handy for taking the places of any that may leak and need repairing. Sun-cracks are liable to occur and cause leakage. For repairing these I have found nothing better than giving them a thick coat of paint, and immediately after laying on the wet paint, a covering of cheese-cloth and painting over this; it will keep the cover rain-proof for many years.

#### WINTER VENTILATION.

It is a serious mistake to greatly diminish the entrance to the hives in winter under the supposition that the natural warmth of the bees is quite conserved. After a series of very exhaustive experiments extending over some months, sometimes with seventeen thermometers in the hive at one time, which I, in conjunction with



another, carried out some twenty-three years ago, it was conclusively proved to our satisfaction that the ventilation of the hives is carried on by the bees through the entrances. The thermometers at the entrance under all conditions proved that fresh air was drawn in at one side while the expended air was driven out from the other side. To avoid dampness within the hive and mouldy combs, allow a good wide entrance in winter.

It is an indication of bad management to have combs go mouldy in a hive, any such should be removed at once; hang them in a warm room for a day or two, a soft brush will then remove the mould.

#### SECURING COVERS IN WINTER.

Hives in an apiary inadequately sheltered are liable to have their covers blown off during high winds, especially in the winter months. If this takes place in a heavy cold rain-storm the colonies may be ruined before matters can be rectified. The covers may be readily and cheaply secured by passing a piece of light fencing wire under the bottom boards and letting the two ends (which should be bent into long hooks) clasp each other. They can be quickly unclashed if necessary to open the hive.

#### AXIOM.

“ BEES DISLIKE ANY QUICK MOVEMENTS ABOUT THEIR HIVES, ESPECIALLY ANY QUICK MOVEMENT WHICH JARS THEIR COMBS.”

*Langstroth.*

## CHAPTER XV.

### DISEASES AND ENEMIES OF BEES.

#### DISEASES.

THE hive-bee (*Apis mellifica*), like all other animals, especially those under domestication, is subject to several diseases, some fortunately of minor importance. The most injurious are those which attack and destroy the brood, thus preventing the normal development of young bees, and the inevitable result of which, when allowed to run their course, is the rapid decline and ultimate extermination of the colonies affected.

The most pernicious of bee-diseases is what we know as "foul-brood," a germ disease of a very infectious nature, and only too familiar to the majority of bee-keepers. It is, without doubt, the greatest drawback to successful bee-culture known at the present time, and seems to be prevalent in all countries where bee-culture is followed.

Recent investigations in America have led the authorities there to distinguish two forms of this disease, one they have named "American," and the other "European," foul brood, but the latter is more frequently spoken of among bee-keepers as "black brood." Objection to the distinguishing names, "American," and "European," has been frequently expressed in England and America as misleading. Be this as it may, however, there are undoubtedly two distinct forms, accompanied chiefly by different bacilli. Dr. G. F. White, bacteriologist, attached to the United States Agricultural Department, who has been the chief investigator there, named the micro-organism associated with "American" foul brood, *Bacillus*

*larvæ*, which, according to Dr. Maassen, of the Imperial Biological Institute, Dahlen, Prussia, is synonymous with *B. Branden burgiensis*, Mausen, and *B. Burri*, Burri. The distinctive bacillus he found in "black brood," and which was constantly present, was *Bacillus alvei*, of Cheshire.

#### FOUL BROOD IN AUSTRALASIA.

On August 2nd, 1907, I sent six typical specimens of diseased comb, three from each end of New Zealand, to Dr. E. F. Phillips, in charge of Agriculture, U.S.A., for examination, and on November the 23rd following I received his report, which was subsequently published in Bulletin No. 18. It will be sufficient for me to observe that after a close investigation of the specimens, making pure cultures from each, and feeding them to healthy colonies, the same disease was produced that was present in the specimens, viz., "American" foul brood (*Bacillus larvæ*). Dr. Phillips wound up his report by saying: "You are then able to say distinctly that American foul brood exists in New Zealand, and that it is caused by *Bacillus larvæ*."

Subsequent experience has not shown that we have any other form of foul brood, nor do I believe any different form exists throughout Australasia at the present time, or I should certainly have heard of it.

#### SYMPTOMS OF FOUL BROOD (*Bacillus larvæ*).

Healthy brood in the larva stage—that is, before it is sealed or capped—presents a clear pearly whiteness, but when attacked, which is usually, as Dr. Phillips remarks, "about the time of capping," changes to a light buff, then to brown. It is, however, when the brood has been capped that the novice is better able to detect the presence of disease.

In the early stage of an attack a capped cell here and there appears somewhat different from the surrounding healthy brood. Instead of the cappings or

seals being bright, full, and of convex form, characteristic of healthy brood, they are of a dull blackish brown colour, and flat or sunken, an indication that the cells contain dead pupæ. The disease rapidly spreads to surrounding cells and combs, if allowed to take its course, till finally no brood can emerge, and the colony succumbs. On opening some of the cells a thin glue-like, pale coffee-coloured mass will be noticed, which on the insertion of a splinter of wood adheres to the point, and can be drawn rope-like for some little distance out of the cells. This is one of the most distinctive features of foul-brood prevalent in New Zealand, and where present is considered conclusive evidence of the disease. Later on this glue-like substance dries up into a black scale-like body.

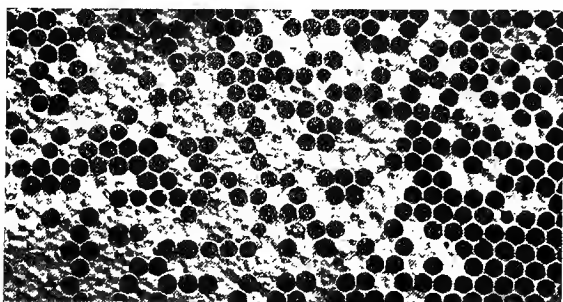

Fig. 79.—PORTION OF DISEASED COMB.

Other symptoms are “pin-holes” and ragged perforations in the cappings of the cells, and a very disagreeable smell resembling that of heated glue or tainted meat, which may be sometimes, though rarely, detected at some yards away from a badly infected hive in close weather. The characteristic odour cannot easily be detected in the earliest stages, even when an infected comb is placed close to the nose, but some slight difference can be noticed between that and healthy comb at all times.

SYMPTOMS OF "BLACK" BROOD (*Bacillus alvei*).

The following is the description given by Dr. E. F. Phillips, in Circular No. 79, Bureau of Entomology, Washington, D.C. :

"Adult bees in infected colonies are not very active, but do succeed in cleaning out some of the dried scales. This disease attacks larvæ earlier than does American foul-brood (*Bacillus larvæ*), and a comparatively small percentage of the diseased brood is ever capped; the diseased larvæ which are capped over have sunken and perforated cappings. The larvæ when first attacked show a small yellow spot on the body near the head, and move uneasily in the cell; when death occurs they turn yellow, then brown, and finally almost black. Decaying larvæ which have died of this disease do not usually stretch out in a long thread when a small stick is inserted and slowly removed; but occasionally there is a very slight 'ropiness,' but this is never very marked. The thoroughly dried larvæ form irregular scales which are not strongly adherent to the lower side wall of the cell. There is very little odour from decaying larvæ which have died from this disease, and when an odour is noticeable it is not the 'glue-pot' odour of American foul-brood, but more nearly resembles that of soured dead brood. This disease attacks drone and queen larvæ very soon after the colony is infected. It is, as a rule, much more infectious than American foul-brood and spreads more rapidly. On the other hand, it sometimes occurs that the disease will disappear of its own accord, a thing which the author never knew to occur in a genuine case of American foul-brood. European foul-brood is most destructive during the spring and early summer, often almost disappearing in late summer and autumn."

TREATMENT OF FOUL BROOD (*Bacillus larvæ*).

We have so abundantly proved the efficacy of the McEvoy treatment of foul brood (*Bacillus larvæ*), in New Zealand, that I unhesitatingly recommend it to every bee-keeper.

Where the disease is so far advanced as to have left few bees in the colony, then it will be safest to destroy everything that has been in contact with it by fire. "Tinkering" with such a colony would be both useless and dangerous.

Treatment may be successfully undertaken at any time when honey is being freely stored. When going through the hives in spring make a note of those showing signs of diseased combs (which are readily detected at that time), for treatment later on, and be very careful that robbing is not started. When the honey season has set in, keeping the bees busy, treatment should begin. All operations in this connection should be carried out in the evening, when the bees are quiet.

Prepare a clean hive and bottom board with narrow starters of comb-foundation in the frames. Remove the infected hive and stand to one side, and put the prepared one in its place, prop up the front about an inch, lay a sack near the entrance, and shake and brush the bees as quietly as possible close to the entrance, and when finished remove every vestige of the infected hive away where bees cannot get at it. The combs, if not too badly infected, may be melted into wax, or, if insufficient in quantity for that purpose, they, with their frames, had better be burned right away and the ashes buried.

On the evening of the fourth day following, the necessary number of frames for the hive should be furnished with full sheets of comb-foundation, to be exchanged with those the bees have been working on. This can be done by removing the frames one at a time, shaking the bees back into the hive, and inserting the others. The comb built on the starters during the four days may be cut out and melted up, and the frames disinfected.

When there are several colonies in an apiary affected with disease, or one here and there in different parts of it, it may be taken for granted that nothing less than the treatment of the whole of the colonies at the same time will be effective. To do otherwise, will be to expend time and labour with no good results.

The theory of this treatment is that during their four days' comb-building, the bees use up all the infected honey contained in their honey-sacs when taken from their old hive, so that when shifted again at the end of the four days they start clean.

## FEEDING AND DISINFECTING.

In all cases when treatment is going on and honey is not being stored freely, feed sugar-syrup liberally after shifting the bees on the fourth day. Mix half a pint of water with each pound of sugar used, stir well, and bring it to the boil; when cool it is ready. Always feed within the hive and in the evening.

Notwithstanding that some authorities, among them McEvoy himself, contend that there is no necessity for disinfecting foul broody hives, I maintain that it is unwise to neglect doing anything within reason that may have a tendency to prevent a further outbreak of disease.

Be sure to remove out of the way of the bees, and disinfect or burn, everything used during the operations of treatment; and a solution of izal should be kept for disinfecting the hands, knives, etc., after handling an infected colony. Directions are given on the bottles, and a weak solution will not harm the skin. Also dig the ground over around the diseased hive-stand. The hive, bottom board, and cover, if sound and worth saving, should be cleaned and thoroughly disinfected with a strong solution of carbolic acid or izal, or singed inside by fire.

## AFTER-INSPECTION.

In from three to four weeks, when the new brood begins to emerge, keep a look-out for any suspicious-looking brood-cells, and if any are seen, cut them out at once, together with the adjoining cells. If suspicious cells recur, treat again fully. "Eternal vigilance" should be the watchword of every bee-keeper who hopes to keep down disease.

## TO PREVENT SWARMING OUT.

On rare occasions colonies swarm out during treatment, but this is not likely to occur when honey is being gathered freely. It can be guarded against by caging

the queen for a few days, or by giving a wide entrance and placing queen-excluding zinc across.

#### SAVING HEALTHY BROOD.

When several colonies are to be treated and there is a large quantity of healthy brood in the combs, put a queen-excluding zinc honey-board over the frames of one of the least-affected hives and put all the healthy brood above this to emerge. When this has been accomplished, remove everything and treat the colony in the manner advised. The zinc prevents the queen making use of the affected combs while the brood is emerging.

#### AUTUMN TREATMENT.

When it is desired to treat colonies in the autumn *after brood-rearing has ceased*, just put the bees into clean hives provided with ample winter stores in the shape of frames of honey from *clean* colonies. The disease is not likely to reappear.

#### YOUNG QUEENS.

There can be little doubt that bees from young vigorous queens can better cope with disease than those bred from aged and weak mothers. It is therefore advisable to change the queens at the time of or shortly after treatment if those in the affected hives are not up to the mark; in any case, it is profitable to do so if young queens can be obtained.

#### TREATMENT OF "BLACK BROOD" (*Bacillus alvei*).

Authorities are still undecided as to the best method of treatment of this disease, but a good number of those who have tried it speak well of that recommended by the late E. W. Alexander, which he had adopted himself with great success. The following is his method put briefly:—

Build up the diseased colonies by uniting them, or giving brood until they are strong; then remove all the



queens, and in nine days go over them carefully and destroy all queen cells; or virgin queens, if hatched. Then start queen rearing from newly hatched larva from your choicest queen (which should be an Italian). On the twentieth day after the old queen was removed, *and not one hour sooner*, for upon this success depends, a ripe queen should be given to each colony from those you have raised. The young queen, in the ordinary course of things, will commence to lay about the twenty-seventh day, or three or four days after the last brood has emerged. The bees in the meantime having cleaned out all the infected cells, the disease is not likely to reappear.

#### OTHER DISEASES.

So little is known concerning the cause and cure of what we know as "Pickle Brood" and "Bee Paralysis," and which are now being investigated that it is needless to dwell upon them here especially as they are not very troublesome so far in this part of the world.

#### "MALIGNANT AND INFECTIOUS DYSENTERY."

Dr. Zander, of Erlangen, Bavaria, has recently been investigating a disease which he refers to as "Malignant and Infectious Dysentery"; it is also frequently spoken of as the "New Disease." He says that it is altogether different to ordinary dysentery, which is harmless in comparison, and that it is the worst bee disease known. It is caused by a parasite germ attacking and destroying the intestinal wall of the bee, which he has named *Nosema apis*. According to Dr. Zander, it belongs to the same family and is closely related to the germ which caused the direful disease among silkworms known as "Pebrine."

For the past few seasons Victoria (Australia) beekeepers have suffered from a disease among their bees, the symptoms of which more or less coincide with those described by Dr. Zander, and from scientific investigations carried out by two Government officers indepen-

dently of each other, they were led to the conclusion that the disease is due to the organism, *Nosema apis*.

#### SYMPTOMS AND REMEDY

Dr. Zander describes the life-history of the germ as follows:—" *Nosema apis* is a parasite which lives in the middle portion of the bees' intestines, devouring and destroying the tissues. If a spore finds its way into the bees' intestines, its shell bursts and the little animal parasite comes forth. It fastens itself to the wall of the intestine, living thereon, and multiplying with astonishing rapidity, entirely consuming and destroying said wall. In four days its work is accomplished, and it again enters into the spore state."

Bees attacked fall to the ground near the hive in large numbers and quickly die; the surrounding ground may be thickly covered with dying bees. The queen soon becomes infected, when the ultimate fate of the infected colony is complete destruction. Fortunately the disease may be further diagnosed as follows:—"A healthy bee's intestine is semi-transparent and flesh-coloured; that of a diseased bee becomes and remains milky-white and opaque. The discolouration or change is a sure sign of the disease, and may be observed without the assistance of a microscope."

Dr. Zander lays special stress upon the following measures to counteract the spread of this disease:—

(1) "Colonies only slightly affected may recover if the queen remains healthy, and a good natural result takes place. (2) The combs contaminated by the excreta of the affected bees are the main cause of the spread of the disease. It is recommended to transfer infected colonies into clean hives fitted with comb foundation. When opportunity occurs, give a sound, healthy queen in place of the old one, as the queens of infected colonies die the following winter. The renewal of the combs forms the basis for successfully combating all bee diseases. The infected hives must be thoroughly cleansed with a solution of soda in hot water."

## ENEMIES.

The list of enemies of the bee usually set down in bee books published in the Northern Hemisphere includes ants, bee moths, some kinds of birds, mice, toads, and wasps.

## ANTS.

New Zealand is singularly free from the larger kinds of ants. In some parts of Australia they are troublesome more or less, but it is not difficult to deal with them. The best plan is to seek out and destroy their nests. Kerosene, or bisulphide of carbon, poured into holes made in the nests with an iron rod or crowbar, will destroy them. If the bisulphide is used, care must be taken with it, as it is very explosive; kerosene is the safest to use and I believe quite as effective as the other.

## BIRDS.

Now and again some of our birds help themselves to a dainty meal off hive-bees. I have occasionally seen kingfishers at this work, and have frequently had to drive sparrows away from near the entrances of hives where they have been catching bees. I don't think much damage is at present done by birds, and it is to be hoped that it will not increase in the future.

With regard to the other animals mentioned, I am not aware that they may be reckoned among the enemies in this part of the world. Mice, and even rats, do sometimes get into hives, but this can only occur where there is a very careless bee-keeper, and nothing further need be said about it.

## THE BEE OR WAX MOTHS.

So far as I am aware, there are only two wax moths in Australasia—the large one, *Galleria mellonella*, and the small one, *Achræa grissella*. The latter we seem to have always had with us, but the former, and the

most destructive one, was first seen in Australia, in 1880, introduced in a colony of Italian bees from Europe, and in New Zealand in 1904, when it was brought under my notice. It was in all probability introduced into this country with bees from Australia. It is the larvæ

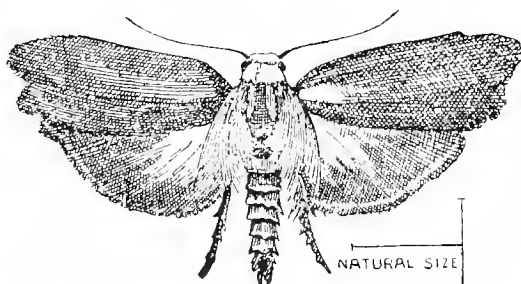

Fig. 80.—LARGE WAX MOTH.

(*Galleria mellonella*.)

or grubs of the moth which prove so destructive to combs, burrowing through them under the protection of strong silk-like galleries (Fig. 81), which they spin around themselves as they advance in their work of destruction. Eventually the combs are completely destroyed, and fall, a mass of web and cocoons to the floor of the hive. The late Mr. Sidney Oliff, Government Entomologist for New South Wales, gave an interesting account of the life-history of the large moth and grubs under the climatic conditions



Fig. 81.—SILKEN TUBE OF BEE MOTH LARVA.

existing in that State, and it is of importance to note that in his opinion four broods of the moth occur in the Sydney district in one season. A tremen-

dous increase when the number of eggs laid by each female moth is taken into consideration.

The average length of the grub is one inch, and "when first hatched is pale yellow with a slightly darker head, and of a greyish flesh colour with a reddish brown head when full grown. The length of the moth is about three-quarters of an inch, has reddish brown-grey forewings, which are lighter in colour towards the outer or hinder margins."

#### THE REMEDY.

That wax-moths, large and small, are only enemies of careless bee-keepers and of those who have not advanced beyond the common box-hive stage is a well-known fact. Careful, up-to-date bee-keepers have nothing to fear from these or any other insect enemies. Follow the golden rule of bee-keeping—viz., "Keep all colonies strong"—and insect enemies will never trouble.

#### FUMIGATING COMBS.

Not only the combs within the hives, but also any which may happen to be unprotected, are liable to be attacked by the moth. No combs or pieces of combs should be allowed to lie about; when they are of no further service they should be melted into wax at once. Spare combs should always be stored in a place of safety from the moth, and inspected frequently. On the first sign of moths or grubs they should be fumigated, and a few days afterwards they should undergo a second fumigation. When there are not many to do they may be suspended in empty hives about one inch apart, and the latter piled one on the other, taking care that the junctions of the boxes are made smoke-tight by pasting a strip of paper round them. The top box of the pile should contain no frames. Into this place an old iron saucepan containing live wood-embers, and on to these throw a couple of handfuls of sulphur, close the cover securely, and keep closed for a couple of days. In a large apiary it is best to have a small room fitted up for the purpose. Two or three pounds of sulphur will be sufficient for a large room.

## CHAPTER XVI.

### THE NEW ZEALAND APIARIES ACT.

THE following is a digest of the Apiaries Act which came into force on September 14th, 1907. It is the first Act of the kind which prohibits the keeping of bees in anything but movable frame hives. The result of this provision in the diminution of foul brood throughout the Dominion has exceeded all expectation.

#### INTERPRETATION.

2. In this Act, if not inconsistent with the context,—

“ Apiary ” means any place where bees are kept :

“ Bee-keeper ” means any person who keeps bees or allows the same to be kept upon any land occupied by him :

“ Disease ” means foul-brood (*Bacillus alvei* and *Bacillus larvæ*), bee-moths (*Galleria mellonella* and *Achræa grizella*), and any other diseases or pests from time to time declared by the Governor in Council to be diseases within the meaning of this Act :

“ Frame hive ” means a hive containing movable frames in which the combs are built, and which may be readily removed from the hive for examination :

“ Inspector ” means any person appointed by the Governor as an Inspector under this Act.

3. Every bee-keeper in whose apiary any disease appears shall, within seven days after first becoming aware of its presence, send written notice thereof to the Secretary for Agriculture, at Wellington, or to any Inspector of Stock.

5. Any Inspector may enter upon any premises or buildings for the purpose of examining any bees, hives, or bee appliances, and if the same are found to be infected with disease he shall direct the bee-keeper to forthwith take such measures as may be necessary to cure the disease; or, if in the opinion of the Inspector the disease is too fully developed to be cured, he may direct the bee-keeper within a specified time to destroy by fire the bees, hives, and appliances so infected, or such portions thereof as the Inspector deems necessary.

6. In any case in which it is found by an Inspector that the bee-combs in any hive cannot, without cutting, be separately and readily removed from the hive for examination, he may direct the bee-keeper to transfer the bees to a new frame hive within a specified time.

7. (1.) Every direction by an Inspector shall be in writing under his hand, and shall be either delivered to the bee-keeper personally or sent to him by registered letter addressed to him at his last-known place of abode.

(2.) Every such direction shall be faithfully complied with by the bee-keeper to whom it is addressed, and, in default of compliance within the time specified, the Inspector may within one month destroy or cause to be destroyed by fire, at the expense of the bee-keeper, any bees, hives, and appliances found to be infected with disease.

8. No bee-keeper shall—

(a.) Keep or allow to be kept upon any land occupied by him any bees, bee-combs, hives, or appliances known by him to be infected by disease without immediately taking the proper steps to cure the disease; or

(b.) Sell, barter, or give away any bees or appliances from an apiary known by him to be infected by disease.

9. No bee-keeper shall, after the expiry of six months from the passing of this Act, keep or knowingly allow to be kept on any land occupied by him any bees except in a properly constructed frame hive.

10. Every person is liable to a fine not exceeding five pounds who—

- (a.) Obstructs an Inspector in the exercise of his duties under this Act, or refuses to destroy or to permit the destruction of infected bees or appliances :
- (b.) Fails to comply with any direction given under the provisions of this Act by an Inspector :
- (c.) Commits any other breach of this Act.

#### AXIOM.

“QUEENLESS COLONIES, UNLESS SUPPLIED WITH A QUEEN, WILL INEVITABLY DWINDLE AWAY, OR BE DESTROYED BY THE BEE-MOTH OR ROBBER-BEES.”

*Langstroth.*



## CHAPTER XVII.

### BEE FORAGE.—BEES IN RELATION TO HORTICULTURE AND AGRICULTURE.

The native bee forage of Australia and New Zealand differ entirely from each other. In the former country the various kinds of Eucalypti, and some of the Acacias, form the chief honey-bearing flora from which the greater part of the commercial honey marketed is gathered. Most of the forest trees indigenous to New Zealand, and there is a great variety, are honey-bearing—some of them remarkably so. It is a fact, however, that the bulk of the honey gathered from the native flora in both countries does not hit the public taste for table use. I have tasted, what I considered, some very fine honey in Australia, gathered from the Gums (Eucalypti) and it is undeniable that we have equally as fine bush honey in New Zealand, but the fact remains that the demand for it is small as compared with that gathered from white clover.

For manufacturing purposes, nothing could be better, as the stronger flavour of the native honey would be more suitable for making up than the milder flavour of clover honey. At present, unfortunately, we have no extensive factories using honey, consequently there is little demand for it for business undertakings of this nature, and the cost of carriage to Europe for low grade honey is too great to pay the sender.

#### WHITE CLOVER HONEY.

There is no room for question that honey gathered from white clover blossoms is the best we know of, and is in the greatest demand the world over. There is no part of Australasia where white clover flourishes so luxuriantly as it does in most parts of New Zealand,

and in some districts clover honey is obtained in its purest condition. The honey which fetches the highest prices on the European markets is from clover, with a proportion of what is termed "dandelion" honey in it, the latter gives it a more pronounced flavour, and a nearer approach to a bright amber colour, so much desired. In Chapter V. I have already advised the prospective commercial bee-keeper to choose a good clover district for establishing his business, and this as a rule, is associated with dairying.

#### BEES AND HORTICULTURE.

My remarks in this connection are particularly relative to fruit growing. Time was, and not long ago, when many orchardists misunderstood the value of the hive-bee as an agent in the production of fruit crops, and as they had seen bees sucking the juices from ripe fruit they concluded that bees were harmful to fruit growers. Thanks, however, to a better knowledge of the subject, it would, I think, be difficult to find an orchardist at the present time who would not welcome the establishment of an apiary in the vicinity of his orchard.

#### BEES DO NOT INJURE FRUIT.

It was commonly believed at one time that bees punctured and destroyed grapes and other delicate fruits, and, notwithstanding that the results of exhaustive experiments conclusively proved the contrary, it took a long time to correct this wrong impression. Bees cannot puncture sound grapes, but during a dearth of honey they will suck the juice from ripe grapes and other fruits *after* they have been punctured by some other animal, or have burst through over-ripeness. Sound grapes smeared with honey have been put into a hive containing a starving colony of bees: the honey has quickly vanished, but not a grape has been injured. Bunches of sound grapes have been left in four or five hives at a time, directly in contact with the bees, and after three weeks every grape was perfectly intact. but

glued to the combs. (See "Langstroth on the Honey-bee," page 507.)

I have always endeavoured by showing the mutual benefits derived by each from the other's work, to bring the horticulturist, agriculturist, and bee-keeper in amicable relations with one another, and in my Bulletin No. 18 (procurable free from the Department of Agriculture, Wellington, N.Z.), I have gone into the question fully. I will, however, make one quotation from it.

Professor A. J. Cook, the well-known American entomologist and apiarist, author of "The Manual of the Apiary," formerly of Michigan Agricultural College, and now of Pomona College, California, who has paid particular attention to this subject, extending over a long period, wrote me a short time ago in reply to some questions I sent him. He said—

"Bees never harm blossoms, but are always a help. Bees are a tremendous aid through pollination. Many of our best fruits must be cross pollinated to produce. Many pears, apples, and plums, etc., are utterly sterile to their own pollen. Bees are alone numerous enough to effect this valuable service. I am sure that it is an incontrovertible fact that bees as the great agents in pollination are far more valuable to the world than for the honey they produce. The best orchardists (in California) now arrange with apiarists to bring their bees to the orchards; they find they must have the bees."

Coming from such an authority, this is eminent testimony as to the value of the hive-bee to orchardists.

#### SHELTER.

Well-sheltered orchards with the bees close at hand would receive the most benefit, especially in boisterous weather. The bees could then utilise every hour of sunshine in visiting the blossoms that would be impossible in exposed situations or where the bees had far to fly.

#### SPRAYING FRUIT TREES.

Every orchardist should understand that the spraying of fruit trees with the usual poisonous mixtures while

in blossom is not only injurious to the blossoms themselves by destroying the pollen, with which the blossoms are fertilised, but also poisons the bees which visit them, and thus defeats the object every fruit grower should keep in view, the cross-fertilisation of the blossoms. In a number of the American States there are laws against doing so.

#### BEES AND AGRICULTURE.

Much of the foregoing concerning cross-fertilisation will apply to agriculturists where pastures are concerned, but the principal objection farmers have brought forward to the establishment of apiaries near their farms has been that in the honey gathered from their pastures they lose so much fattening matter that would have benefited their stock. As I have already gone fully into this matter, and shown the folly of this idea in my *Bulletin* mentioned above, I would ask those interested to apply for a copy. All I need say here is, that bees while conferring great benefits on agriculture, do no harm whatever, and that the presence of an apiary, on or close to his land, can be nothing but an advantage to the agriculturist.

#### FLIGHT OF BEES.

There is considerable difference of opinion as to the distance bees will fly for food; some think they will go six miles or more if there is sufficient inducement. What concerns bee-keepers most is not how far they will fly, but how far can they go to gather honey with profit to their owner; or, in other words, how near to their forage should they be. The consensus of opinion is, they should not have to fly beyond a radius of two miles in any direction, and I am of the same opinion myself.

## CHAPTER XVIII.

### BEEES IN RELATION TO AGRICULTURE.\*

THE benefits derived by both agriculturists and horticulturists from the labours of the bee are now very generally understood and acknowledged; but still, cases have sometimes occurred, though rarely, of farmers objecting to the vicinity of an apiary, and complaining of bees as "trespassers," instead of welcoming them as benefactors.

#### ARE BEEES TRESPASSERS?

It is not, perhaps, surprising that at first a man should imagine he was being injured in consequence of bees gathering honey on his land, to be stored up elsewhere, and for the use of other parties; he might argue that the honey belonged by right to him, and even jump at the conclusion that there was so much of

---

\* This paper, which constituted the nineteenth chapter of the third edition of this Manual, was an attempt, and I have reasons for believing a successful attempt, to clear up several misunderstandings that had arisen in the minds of some farmers who had come to regard the working of our neighbours' bees in their pasturage as detrimental to themselves, and to prove on the contrary that it is really to their interests to encourage bee-keeping. Shortly after the paper was first published the subject was brought prominently forward in consequence of the action taken by a farmer in the United States to claim damages from a neighbouring bee-keeper for alleged injury done to his grazing sheep by trespassing (?) bees. Needless to say, he lost his case. The paper has been extensively quoted in several American bee journals, and described as a "unique and valuable addition to bee literature." I trust it may still serve a good purpose in this country, where it first appeared.—I.H.

the substance of the soil taken away every year, and that his land must therefore become impoverished. It is true that if he possessed such an amount of knowledge as might be expected to belong to an intelligent agriculturist, working upon rational principles, he should be able, upon reflection, to see that such ideas were entirely groundless. Nevertheless, the complaint is sometimes made, in a more or less vague manner, by persons who ought to know better; and even bee-keepers appear to have occasionally adopted an apologetic tone, arguing that "bees do more good than harm," instead of having taken the much higher and only true stand by asserting that bees, while conferring great benefits on agriculture, do no harm whatever, and that the presence of an apiary on or close to his land can be nothing but an advantage to the agriculturist.

#### BENEFICIAL INFLUENCE OF BEES ON AGRICULTURE.

The value of the intervention of bees in the cross-fertilisation of plants is dwelt upon in Chapter III., "Australasian Bee Manual," third edition, and the reader is referred for further information to the works of Sir J. Lubbock (Lord Avebury) and of Darwin. The latter, in his work on "Cross and Self Fertilisation of Plants," gives the strongest evidence as to the beneficial influence of bees upon clover-crops. At page 169, when speaking of the natural order of leguminous plants, to which the clovers belong, he says, "The cross-seedlings have an enormous advantage over the self-fertilised ones when grown together in close competition"; and in Chapter X., page 361, he gives the following details of some experiments, which show the importance of the part played by bees in the process of cross-fertilisation:—

*Trifolium repens* (White Clover).—Several plants were protected from insects, and the seeds from ten flower-heads on these plants and from ten heads on other plants growing outside the net (which I saw visited by bees) were counted, and the seeds from the latter plants were very nearly ten times as numerous as those from the protected plants. The experiment was repeated in the following year, and twenty protected heads now yielded only a single abortive seed, whilst twenty heads on the plants outside the net (which I

saw visited by bees) yielded 2,290 seeds, as calculated by weighing all the seeds and counting the number in a weight of two grains.

*Trifolium pratense* (Purple Clover).—One hundred flower-heads on plants protected by a net did not produce a single seed, whilst one hundred on plants growing outside (which were visited by bees) yielded 68 grains' weight of seed; and, as eighty seeds weighed two grains, the hundred heads must have yielded 2,720 seeds

Here we have satisfactory proof that the effect of cross-fertilisation brought about by bees upon the clovers and other plants growing in meadows and pasture-lands is the certain production of a large number of vigorous seeds, as compared with the chance only of a few and weak seeds if self-fertilisation were to be depended upon. In the case of meadow-cultivation, it enables the farmer to raise seed for his own use or for sale, instead of having to purchase it, while at the same time the nutritious quality of the hay is, as we shall see further on, improved during the process of ripening the seed. In the case of pasture-lands, such of those vigorous seeds as are allowed to come to maturity and to fall in the field will send up plants of stronger growth to take the place of others that may have died out, or to fill up hitherto-unoccupied spaces, thus tending to cause a constant renewal and strengthening of the pasture. The agriculturist himself should be the best judge of the value of such effects.

The beneficial effect of the bees' visits to fruit-trees has been well illustrated by Mr. Cheshire in the pages of the *British Bee Journal* and by Professor Cook in his articles upon "Honey Bees and Horticulture" in the *American Apiculturist*. In fact, even those who complain of bees cannot deny the services they render; what they contest is the assertion that bees do no harm.

#### CAN BEES HARM THE SOIL OR THE CROPS?

is, then, the question to be considered. The agriculturist may say, "Granting that the visits of bees may

be serviceable to me in the fertilisation of my fruit or my clover, how will you prove that I am not obliged to pay too high a price for such services?" For the answer to such a question one must fall back upon the researches of the agricultural chemist, which will furnish satisfactory evidence to establish the two following facts: First, that saccharine matter, even when assimilated and retained within the body of a plant, is not one of the secretions of vegetable life which can in any way tend to exhaust the soil, being made up of constituents which are furnished everywhere in superabundance by the atmosphere and rain-water, and not containing any of the mineral or organic substances supplied by the soil or by the manures used in agriculture; and, secondly, that in the form in which it is appropriated by bees, either from the nectaries of flowers or as honeydew from the leaves, it no longer constitutes a part of the plant, but is in fact an excrement, thrown off as superfluous, which if not collected by the bee and by its means made available for the use of man would either be devoured by other insects which do not store honey, or be resolved into its original elements and dissipated in the air.

The foregoing statements can be supported by reference to authorities which can leave no doubt as to their correctness—namely, Sir Humphrey Davy in his "Elements of Agricultural Chemistry," written more than seventy years ago, and Professor Liebig in his "Chemistry in its Application to Agriculture and Physiology," written some ten years later, and the English version of which is edited by Dr. Lyon Playfair and Professor Gregory. These works, which may be said to form the foundation of a rational system of agriculture, were written with that object alone in view, and the passages about to be quoted were not intended to support any theory in favour of bee-culture or otherwise; they deal simply with scientific truths which the layman can safely follow and accept as true upon such undeniable authority, although he may be incapable himself of following up the processes which have led to their discovery or which prove their correctness.



SACCHARINE MATTER OF PLANTS NOT DERIVED FROM  
THE SOIL.

Liebig, when describing the chemical processes connected with the nutrition of plants, informs us (at page 4\*) that—

There are two great classes into which all vegetable products may be arranged. The first of these contains nitrogen; in the last this element is absent. The compounds destitute of nitrogen may be divided into those in which oxygen forms a constituent (starch, lignine, etc.) and those into which it does not enter (oils of turpentine, lemon, etc.).

And, at page 141, that—

Sugar and starch do not contain nitrogen; they exist in the plants in a free state, and are never combined with salts or with alkaline bases. They are compounds formed from the carbon of the carbonic acid and the elements of water (oxygen and hydrogen).

Sir Humphrey Davy had already stated that, "according to the latest experiments of Gay Lussac and Thenard, sugar consists of 42.47 per cent. of carbon and 57.23 per cent. of water and its constituents." Now, Liebig in several parts of his work shows that the carbon in sugar and all vegetable products is obtained from carbonic acid in the atmosphere; and that "plants do not exhaust the carbon of the soil in the normal condition of their growth; on the contrary, they add to its quantity."

## DERIVED FROM THE ATMOSPHERE AND RAIN-WATER.

The same authority shows that the oxygen and hydrogen in these products are derived from the atmosphere and from rain-water; and that it is only the products containing nitrogen (such as gluten or albumen in the seeds or grains), and those containing mineral matter

---

\* The edition to which reference is made is the fourth, published in 1847.

(silex, lime, aluminium, etc.), which take away from the soil those substances that are required to be returned to it in the shape of manures. The saccharine matter, once it is secreted by the plant and separated from it, is even useless as a manure. Liebig says on this head, page 21,—

The most important function in the life of plants, or, in other words, in their assimilation of carbon, is the separation—we might almost say the generation—of oxygen. No matter can be considered as nutritious or as necessary to the growth of plants which possesses a composition either similar to or identical with theirs, because the assimilation of such a substance could be effected without the exercise of this function. The reverse is the case in the nutrition of animals. Hence such substances as sugar, starch, and gum, themselves the products of plants, cannot be adapted for assimilation; and this is rendered certain by the experiments of vegetable physiologists, who have shown that aqueous solutions of these bodies are imbibed by the roots of plants and carried to all parts of their structure, but are not assimilated; they cannot, therefore, be employed in their nutrition.

#### NECTAR OF PLANTS INTENDED TO ATTRACT INSECTS.

The secretion of saccharine matter in the nectaries of flowers is shown to be one of the normal functions of the plant, taking place at the season when it is desirable to attract the visits of insects for the purposes of its fertilisation. It may, then, be fairly asserted that the insect, when it carries off the honey from any blossom it has visited, is merely taking with it the fee or reward provided by nature for that special service.

#### SOMETIMES THROWN OFF AS SUPERFLUOUS.

There are, however, occasions when considerable quantities of such matter are thrown off or exuded by the leaves, which effect is taken to indicate an abnormal or unhealthy condition of the plant. At pages 106 and 107 of Liebig's book (speaking of an experiment made to induce the rising sap of a maple-tree to dissolve raw

sugar applied through a hole cut in the bark) he shows that,—

When a sufficient quantity of nitrogen is not present to aid in the assimilation of the substances destitute of it, these substances will be separated as excrements from the bark, roots, leaves, and branches.

In a note to this last paragraph we are told that—

Langlois has lately observed, during the dry summer of 1842, that the leaves of the linden-tree became covered with a thick and sweet liquid in such quantities that for several hours of the day it ran off the leaves like drops of rain. Many kilograms might have been collected from a moderate-sized linden-tree.

And further on, at page 141, he says,—

In a hot summer, when the deficiency of moisture prevents the absorption of alkalies, we observe the leaves of the lime-tree, and of other trees, covered with a thick liquid containing a large quantity of sugar; the carbon of the sugar must, without doubt, be obtained from the carbonic acid of the air. The generation of the sugar takes place in the leaves, and all the constituents of the leaves, including the alkalies and alkaline earths, must participate in effecting its formation. Sugar does not exude from the leaves in moist seasons, and this leads us to conjecture that the carbon which appeared as sugar in the former case would have been applied in the formation of other constituents of the tree in the event of its having had a free and unimpeded circulation.

These quotations will probably be considered sufficient to justify the assertion that the gathering of the honey from plants can in no possible way tend to exhaust the soil or affect its fertility. There is no difference of opinion among scientific men as to the sources from which the saccharine matter of plants is derived. Since Liebig first put forward his views on that subject, as well as with regard to the sources from which the plants derive their nitrogen, the principles of agricultural chemistry have been studied by the most eminent chemists, some of whom combated the views of Liebig on this latter point (the source of nitrogen and its compounds), and Liebig himself seems to have modified

his views on that point; but there has been no difference of opinion about the saccharine matter, as to which Liebig's doctrine will be found given unaltered in the latest colonial work on the subject, MacIvor's "Chemistry of Agriculture," published at Melbourne a few years ago.

SUPERFLUOUS NECTAR EVAPORATED IF NOT TAKEN BY  
INSECTS.

That the nutritive quality of the plants in any growing crop is not diminished by the abstraction of honey from their blossoms would appear to be evident from the fact already referred to, that those plants have actually thrown off the honey from the superfluity of their saccharine juices as a matter which they could no longer assimilate. There would appear, on the other hand, to be good reason to believe that the plants themselves become daily more nutritive during the period of their giving off honey—that is, from the time of flowering to that of ripening their seeds. This is a point upon which, I believe, all agricultural chemists are not quite agreed, but the testimony of Sir H. Davy is very strong in favour of it. In the appendix to his work already quoted, he gives the results of experiments made conjointly by himself and Mr. Sinclair, the gardener to the Duke of Bedford, upon nearly a hundred different varieties of grasses and clovers. These were grown carefully in small plots of ground as nearly as possible equal in size and quality; equal weights of the dried produce of each, cut at different periods, especially at the time of flowering and at that of ripened seeds, were "acted upon by hot water till all their soluble parts were dissolved; the solution was then evaporated to dryness by a gentle heat in a proper stove, and the matter obtained carefully weighed, and the dry extract, supposed to contain the nutritive matter of the plants, was sent for chemical analysis." Sir H. Davy adds his opinion that his "mode of determining the nutritive power of grasses is sufficiently accurate for all the purposes of agricultural investigation." Further on he

reports, "In comparing the compositions of the soluble products afforded by different crops from the same grass, I found, in all the trials I made, the largest quantity of truly nutritive matter in the crop cut when the seed was ripe, and the least bitter extract and saline matter and the most saccharine matter, in proportion to the other ingredients, in the crop cut at the time of flowering." In the instance which he then gives, as an example, the crop cut when the seed had ripened showed 9 per cent. less of sugar, but 18 per cent. more of mucilage and what he terms "truly nutritive matter," than the crop cut at the time of flowering. From this it would follow that during the time a plant is in blossom and throwing off a superfluity of saccharine matter in the shape of honey, the assimilation of true nutritive matter in the plant itself is progressing most favourably. In any case it is clear that the honey, being once exuded, may be taken away by the bees or any other insects (as it is evidently intended to be taken) without any injury to the plant, by which it certainly cannot be again taken up, but must be evaporated if left exposed to the sun's heat.

#### QUESTION AS TO GRAZING STOCK.

THERE is, however, a plea put in by the agriculturist on behalf of his grazing stock, and one which he generally seems to consider unanswerable. He says, "Even if it be admitted that the removal of the honey from my farm is neither exhausting to the soil nor injurious to the plants of the standing crop, still it is so much fattening-matter which might be consumed by my stock if it had not been pilfered by the bees."

Now, it may at once be admitted that honey consists to a great extent of fattening matter, though it may be allowable to doubt whether in that particular form it is exactly suitable as food for grazing cattle. Although it is quite true that the saccharine matter assimilated in the body of a plant tends to the formation of fat in the animal which eats and digests that plant, still one may question the propriety of feeding

the same animal on pure honey or sugar. We may, however, waive that view of the subject, as we shall shortly see that it is only a question of such homœopathically small doses as would not be likely to interfere with the digestion of the most delicate grazing animal, any more than they would considerably increase its weight. Admitting, therefore, that every pound of honey of which the grazing stock are deprived by bees is a loss to the farmer, and therefore to be looked upon as a set-off to that extent against the benefit conferred by the bees in other ways, it will be necessary to consider to what extent it is possible that such loss may be occasioned.

#### QUANTITY OF HONEY FURNISHED BY PASTURE-LAND.

In the first place, it must be recollected that a large proportion—in some cases the great bulk—of the honey gathered by bees is obtained from trees, as, for instance, the linden in Europe, the bass-wood and maple in America, and in this country the forest-trees, nearly all of which supply rich forage for the bee, and everywhere from fruit trees in orchards. A large quantity is gathered from flowers and flowering shrubs reared in gardens; from clover and other plants grown for hay, and not for pasture; and even in the field there are many shrubs and flowering plants which yield honey, but which are never eaten by cattle. Pastures, therefore, form but a small part of the sources from which honey is obtained; and in dealing with this grazing question we have to confine our enquiries to clovers and other flowering-plants grown in open pastures, and such as constitute the ordinary food of grazing stock. In order to meet the question in the most direct manner, however, let us assume the extreme case of a large apiary being placed in a district where there is nothing else but such open pastures, and growing only such flowering-plants as are generally eaten by stock. Now, the ordinary working-range of the bee may be taken at a mile and a half from the apiary on all sides, which gives

an area of about 4,500 acres for the supply of the apiary; and if the latter consists of a hundred hives, producing an average of 100 lb. of honey, there would be a little more than 2 lb. of honey collected off each acre in the year; or, if we suppose so many as two hundred hives to be kept at one place, and to produce so much as 10 tons of honey in the season, the quantity collected from each acre would be 4 lb. to 5 lb.

#### PROPORTION POSSIBLY CONSUMED BY STOCK.

Let us next consider what proportion of those few pounds of honey could have found its way into the stomachs of the grazing stock if it had not been for the bees. It is known that during the whole time the clover or other plants remain in blossom, if the weather be favourable, there is a daily secretion of fresh honey, which, if not taken at the proper time by bees or other insects, is evaporated during the mid-day heat of the sun. It has been calculated that a head of clover consists of fifty or sixty separate flowers, each of which contains a quantity not exceeding one five-hundredth part of a grain in weight, so that the whole head may be taken to contain one-tenth of a grain of honey at any one time. If this head of clover is allowed to stand until the seeds are ripened it may be visited on ten or even twenty different days by bees, and they may gather on the whole, one, or even two, grains of honey from the same head, whereas it is plain that the grazing animal can only eat the head once, and consequently can only eat one-tenth of a grain of honey with it. Whether he gets that one-tenth grain or not depends simply on the fact whether or not the bees have exhausted that particular head on the same day just before it was eaten. Now, cattle and sheep graze during the night and early morning, long before the bees make their appearance some time after sunrise; all the flowering plants they happen to eat during that time will contain the honey secreted in the evening and night-time; during some hours of the afternoon the flowers will contain no honey,

whether they have been visited by bees or not; and even during the forenoon, when the bees are not busy, it is by no means certain that they will forestall the stock in visiting any particular flower. If a field were so overstocked that every head of clover should be devoured as soon as it blossomed, then, of course, there would be nothing left for the bees; but if, on the other hand, as is generally the case, there are always blossoms left standing in the pasture, some of them even till they wither and shed their seeds, then it must often happen that after bees shall have visited such blossoms ten or even twenty times, and thus collected one or even two grains of honey from one head, the grazing animal may, after all, eat that particular plant and enjoy his one-tenth of a grain of honey just as well as if there had never been any bees in the field. If all these chances be taken into account it will be evident that out of the 4 lb. or 5 lb. of honey assumed to be collected by bees from one acre of pasturage, probably not one-tenth, and possibly not one-twentieth, part could under any circumstances have been consumed by the grazing animals—so that it becomes a question of a few ounces of fattening-matter, more or less, for all the stock fed upon an acre during the whole season; a matter so ridiculously trivial in itself, and so out of all proportion to the services rendered to the pasture by the bees, that it may be safely left out of consideration altogether.

#### BEE-KEEPING AS A BRANCH OF FARMING.

There is still one point which may possibly be raised by the agriculturist or landowner: "If the working of bees is so beneficial to my crops, and if such a large quantity of valuable matter may be taken, in addition to the ordinary crops, without impoverishing my land, why should I not take it instead of another person who has by right no interest in my crop or my land?" The answer to this is obvious. It is, of course, quite open to the agriculturist to keep any number of bees he may think fit; only, he must consider well in how far it will pay him to add the care of an apiary to his other duties,



No doubt every one farming land may with advantage keep a few stands of hives to supply his own wants in honey—the care of them will not take up too much of his time, or interfere much with his other labours; but if he starts a large apiary with the expectation that it shall pay for itself, he must either give up the greater portion of his own time to it or employ skilled labour for that special purpose; and he must recollect that the profits of bee-keeping are not generally so large as to afford more than a fair remuneration for the capital, skill, and time required to be devoted to the pursuit. In any case, he cannot confine the bees to work exclusively on his own property, unless the latter is very extensive. When such is the case he may find it greatly to his advantage to establish one or more apiaries to be worked under proper management, as a separate branch of his undertaking; but in every case, whether he may incur or share the risks of profit and loss in working an apiary or not, the thing itself can only be a source of unmixed advantage to his agricultural operations, and consequently if he does not occupy the ground in that way himself he should be glad to see it done by any other person.

#### AXIOM.

“ BEES DISLIKE THE OFFENSIVE ODOUR OF SWEATY ANIMALS, AND WILL NOT ENDURE IMPURE AIR FROM HUMAN LUNGS.”

*Langstroth.*

## CHAPTER XIX.

### CALENDAR AND BEE-KEEPER'S AXIOMS.

#### VARIABILITY OF SEASONS.

NO *invariable* rules can be laid down for the work to be done in an apiary each month, which can be strictly followed in *every* place, nor even in the same place in *every* year. The whole plan of operations must be suited in the first place to the normal climate of the district in which the apiary is situated, the nature of the bee forage available both in the spring and the honey season, and to the natural habits of the bees as influenced by their local peculiarities. If these circumstances be properly taken into account, a set of general rules may be established suitable to the average of seasons; but even these must be liable to modifications at the judgment of the apiarist, according to the variations, or the more or less abnormal features, of different seasons.

In the arrangement of apiary work for the different months throughout the year, as a handy guide to the novice, I have chosen the dates of the average bee seasons for the latitude of Auckland, New Zealand, as a basis to calculate from. In many parts of Australia the seasons are earlier, while those in Tasmania approximate closely to those in New Zealand to the South of Auckland.

*January.*—In average seasons a goodly proportion of the crop of honey is secured this month in districts South of Auckland, and in some parts of the extreme South the main portion is taken. Swarming still continues, but every effort should be made to keep it down, otherwise it will seriously interfere with the honey yield. Remove sections from the hives as soon as completely sealed, and place them in the honey house for a few days to ripen before packing them for market; take care that there are no bee moths in the house. Extract as often as necessary the surplus honey in frames. Supersede old queens.

*February.*—Unless the weather is hot and dry, as it occasionally is this month, a considerable quantity of honey is gathered during the first half, but care should be taken not to deprive the hives too closely in case the honey season suddenly closes, when the bees would be left short of food. Beware of robber bees as soon as the honey flow ceases, and don't give them an opportunity to pillage, otherwise there will be trouble. Return any swarms that issue. Supersede old and defective queens.

*March.*—Robbers will still be troublesome where they have the least chance to carry on their work of plundering. Keep a good look-out for them. See that each colony has a plentiful supply of food, so that brood-rearing may be kept up. The honey-season practically closes at the early part of this month. All hives, etc., as they drop out of use should be disinfected with a solution of carbolic acid, or other good disinfectant, before being stored away for the winter. Now is a good time to paint hives and repair covers.

*April.*—It is important that brood-rearing should be kept up all through the autumn, so that there may be plenty of young bees to go into winter quarters; to this end there should be plenty of food in the hives. All weak and queenless colonies should now be united with others. Symptoms of foul-brood are more distinct at this time and in the spring of the year, and should be dealt with accordingly.

*May.*—All colonies should be overhauled and be prepared for winter as early as possible this month. Unite weak and queenless colonies overlooked last month, see that there is plenty of food in each hive, and that there are no leaky covers.

*June.*—This should be a quiet month in the apiary if the previous instructions have been carried out. The less bees are meddled with during winter the better.

*July.*—Look out for leaky covers and damp mats, remove and repair defective covers, and give dry mats where required. Remove all surplus boxes that are now on the hives, and put on one or two extra mats, as breeding will commence towards the end of the month.

*August.*—All hives should be well overhauled on the first fine days of this month and the condition of each noted. See to the food supply, and feed where short, as a larger quantity will now be required for feeding the brood. Clean

the bottom boards, and put in division boards where required. As breeding will have commenced, care should be taken to keep the interior of the hives warm. Remove any combs that are mouldy. Place the hive on a stand alongside while cleaning the bottom board. Unite weak and queenless colonies, and stimulate those required for queen-rearing purposes. Make up hives, frames, etc., and send orders to the manufacturers for material required for the coming season. Willows and early-flowering peach-trees blossom at the end of the month.

*September.*—The food supply should be attended to as advised last month. Brood-rearing should now go on steadily. Should the weather be against the bees see that they don't run short of food. Look out for symptoms of foul-brood and deal with it at once. Queen-rearing may be started at end of month if weather suitable. Swarming commences to the North of Auckland, and also in many of the warmer parts of Australia this month.

*October.*—The honey season in districts North of Auckland and in Australia begins this month. Swarming becomes pretty general throughout New Zealand sooner or later this month, according to the season. Put on top boxes where swarms are not required. See to the ventilation as the weather gets warmer. Unite small colonies. Transferring may be done.

*November.*—The first batch of queens should be ready this month, though in the warmer parts of Australasia they would have been ready for distribution more than a month ago. This is the best month for Italianising the apiary. Give plenty of working room for the bees, and remove surplus honey as soon as it is ready. Look out for swarms.

*December.*—Supersede all worthless queens, and keep down swarming by affording sufficient working room. The first of the clover honey is usually secured this month, and everything should be done to assist in securing the largest crop while the clover lasts.

### BEE-KEEPER'S AXIOMS.

Mr. Langstroth, in his invaluable work so often alluded to in these pages, has given the following axioms as "a few of the *first principles* in bee-keeping," which ought to be as familiar to the apiarian "as the letters of his alphabet." They are so true, that they

are still, and must continue to be, as important to all bee-keepers, whether novices or experts, as they were when first penned. I have already given each a prominent position at the close of some of the preceding chapters, in order the better to impress them on the mind of the reader :—

1. Bees gorged with honey never volunteer an attack.
2. Bees may always be made peaceable by inducing them to accept of liquid sweets.
3. Bees, when frightened by smoke or by drumming on their hives, fill themselves with honey, and lose all disposition to sting, unless they are hurt.
4. Bees dislike any *quick* movements about their hives, especially any quick movement which *jars* their combs.
5. Bees dislike the offensive odour of sweaty animals, and will not endure impure air from human lungs.
6. The bee-keeper will ordinarily derive all his profits from stocks strong and healthy in early spring.
7. In districts where forage is abundant only for a short period, the largest yield of honey will be secured by a *very* moderate increase of stocks.
8. A moderate increase of colonies in any one season will, in the long run, prove the easiest, safest, and cheapest mode of managing bees.
9. Queenless colonies, unless supplied with a queen, will inevitably dwindle away, or be destroyed by the bee moth, or by robber bees.
10. The formation of new colonies should ordinarily be confined to the season when bees are *accumulating* honey; and if this, or any other operation, must be performed when forage is scarce, the greatest precautions should be used to prevent robbing.

The essence of all profitable bee-keeping is contained in Oettl's golden rule—*Keep your stocks strong*. If you cannot succeed in doing this, the more money you invest in bees the heavier will be your losses; while if your stocks are strong, you will show that you are a *bee-master* as well as a bee-keeper, and may safely calculate on a generous return from your industrious subjects.

L. J. BAGNALL, Managing Director.  
H. C. BAGNALL, Auckland Manager.

Directors.—  
J. A. POND.  
R. W. BAGNALL.

---

# BAGNALL BROS. & CO., LIMITED.

(ESTABLISHED 1874.) (AUCKLAND BRANCH.)

Successors to I. HOPKINS & Co. as

**Hive Manufacturers & Importers**

OF ALL

## Modern Apiarian — Appliances —

We supply every article illustrated or mentioned in this  
"Australasian Bee Manual."

### *ITALIAN BEES AND QUEENS*

We make a speciality of our Italian Queen and Bee business, our Breeding Stock being of the best strains procurable. The constant repeat orders received testify to the satisfaction given.

---

SEND FOR OUR LARGE AND  
COMPLETE ILLUSTRATED CATALOGUE (posted  
free.)

---

BAGNALL BROS. & Co., Ltd.,  
Wellesley Street, Auckland, N.Z.

Herne Bay Trams, starting from foot of Queen Street,  
stop at the Factory at end of penny section.

# INDEX.

	PAGE		PAGE
Additional Top Boxes ... ..	117	Bee-keepers' Axioms ... ..	168
Advice to Beginners ... ..	5	Bee-keeping, as a Branch of	
After-Inspection ... ..	139	Farming ... ..	164
Alley Plan ... ..	96	in Australasia ... ..	4
Ants ... ..	143	Modern Art of ... ..	2
Apiary, The ... ..	39	Origin of the Art of ... ..	1
Arrangement of ... ..	41	Profits of ... ..	5
Location of ... ..	39	Beeswax ... ..	28
Apiaries, Out ... ..	45	Beginners, Advice to ... ..	5
Autumn and Winter Manage-		Birds ... ..	143
ment ... ..	127	Black Brood, Symptoms of ... ..	137
Breeding ... ..	128	Treatment of ... ..	140
Treatment ... ..	140	Buildings ... ..	42
Axioms, Bee-keepers' ... ..	168	Cages, Introducing ... ..	104
"Bait" Sections ... ..	125	Calendar ... ..	166
Bee, Black or Common ... ..	7	Candy ... ..	105
Cyprian, Syrian, Holy Land	7	Cappings Melter ... ..	75
Escapes ... ..	128	Caution ... ..	110
Forage: Bees in Relation to		Cells, Swarming ... ..	107
Horticulture and Agricul-		Cleaning Wax, Sulphuric Acid for	36
ture ... ..	149	Clipping Queen's Wings ... ..	106
Head of the Worker ... ..	13	Comb, Baskets and Brush ... ..	118
or Wax Moths ... ..	143	Cutting the ... ..	98
Stings, Cure for ... ..	80	Holder ... ..	82
Veils and Smokers ... ..	77	Honey, Working for ... ..	125
Bees, and Agriculture ... ..	152	Room ... ..	44
and Horticulture ... ..	150	Combs, Fumigating ... ..	145
Are they Trespassers? ... ..	153	Honey and Brood ... ..	37
Beneficial Influence of, on		Rendering into Commercial	
Agriculture ... ..	154	Wax ... ..	32
Can they harm Soil or Crops? ... ..	155	Comb Foundation ... ..	65
Carniolan ... ..	7	Embedding Wire in ... ..	69
Diseases of ... ..	134	Fastening in Frames ... ..	68
Do not injure Fruit ... ..	150	Use of ... ..	66
Driving ... ..	83	Contracting Hive Space ... ..	111
Enemies of ... ..	143	"Daisy" Barrow ... ..	119
Flight of ... ..	152	Development from Egg to Bee ... ..	18
Handling ... ..	77	Diseases of Bees ... ..	134
Hybrid ... ..	9	After-Inspection ... ..	139
in Relation to Agriculture ... ..	153	Autumn Treatment ... ..	140
Introduction into Australasia	2	Black Brood, Symptoms of	137
Italian ... ..	8	Treatment of ... ..	140
Moving ... ..	45	Feeding and Disinfecting ... ..	139
Relative Sizes of ... ..	11	Foul Brood in Australasia ... ..	135
Structural Organization ... ..	13	Symptoms of ... ..	135
Transferring ... ..	83	Treatment of ... ..	137
What They Collect and What			
They Produce ... ..	26		

PAGE		PAGE	
	Diseases of Bees— <i>con.</i>		Honey— <i>con.</i>
	" Malignant and Infectious		Bee and its Varieties ... 7
	Dysentery" ... .. 141		Dew ... .. 27
	Symptoms and Remedy ... 142		Liquefying Granulated ... 124
	Other Diseases ... .. 141		Motor Power for Extracting ... 73
	Saving Healthy Brood ... .. 140		Proportion Possibly Con-
	To Prevent Swarming Out ... 139		sumed by Stock ... .. 163
	Young Queens ... .. 140		Quantity of, Furnished by
			Pasture Land ... .. 162
	Doolittle Plan ... .. 95		Ripening Extracted ... .. 120
	Dronc Trap ... .. 105		Strainers ... .. 123
	Dysentery, Malignant and In-		Supers, Surplus (Extracted
	fectious ... .. 141		Honey) ... .. 115
	Symptoms and Remedy ... 142		Surplus ... .. 111
			Taking the Last Surplus ... 127
	Embedding Wire in Foundation ... 69		White Clover ... .. 149
	Enemies of Bees ... .. 143		Honey Extractor - Extracting
	Ants ... .. 143		Appliances ... .. 71
	Bee or Wax Moths ... .. 143		
	Remedy ... .. 145		Increase by Artificial Means ... 93
	Birds ... .. 143		Natural Swarming ... .. 86
	Extracting ... .. 118		Increasing, Natural and Artificial ... 85
	Extracting House ... .. 42		Inmates of the Hive: Their
	Windows ... .. 44		Natural History ... .. 10
	Fastening Foundation in Frames ... 64		Introductory and Historical ... 1
	Feeders ... .. 114		Italianising ... .. 106
	Feeding and Disinfecting		Liquefying Granulated Honey ... 124
	in Queen Rearing ... .. 108		Location ... .. 39
	Spring ... .. 112		
	Stimulative ... .. 113		Markings of Pure Italians ... 8
	Forming Nuclei ... .. 100		Mats for Covering Frames ... 63
	Foul Brood in Australasia ... 135		and Covers, Extra ... .. 132
	Symptoms of ... .. 135		
	Treatment of ... .. 137		Natural Swarming, Increase by ... 86
	Frames, Broad Section ... .. 62		Nectar of Plants ... .. 158
	Handling ... .. 81		Superfluous ... .. 160
	Mats for Covering ... .. 63		" New Zealand Apiaries Act " ... 146
	Number of to Hive ... .. 63		
	Numbering the ... .. 120		Overstocking a District ... .. 46
	Self-Spacing ... .. 60		
	Shallow Extracting ... .. 61		Parthenogenesis ... .. 18
	Fuel for Smokers ... .. 78		Pollen and Bee-bread ... .. 37
	Fumigating Combs ... .. 145		Precautions ... .. 130
			Preparation for Swarms ... .. 87
	Gloves ... .. 80		Preparing Colony for Cell Build-
	Grazing Stock, Question as to ... 161		ing ... .. 99
			Prevention of After-swarms ... 92
	Hive, A Cheap Frame ... .. 59		Propolis ... .. 38
	Cramp ... .. 58		
	How to Open a ... .. 81		Queen and Brood, Returning ... 99
	Langstroth ... .. 48		Nurseries ... .. 102
	Number of Frames to ... .. 63		Reproductive Organs of ... 15
	Space, Contracting ... .. 111		Queens, Choice of Breeding ... 94
	Hives ... .. 47		Emerging and Mating of ... 101
	Frames and Section Boxes ... 47		Introducing ... .. 103
	Instructions for Making ... 49		Superseding ... .. 107
	Nucleus ... .. 57		Young ... .. 140
	Nucleus ... .. 100		Queen Cells, Raising ... .. 95
	Observatory ... .. 57		Wood Bases for ... .. 108
	Painting ... .. 57		Queen-excluding Honey Boards ... 116
	Hiving ... .. 90		Queen Rearing ... .. 94
	Hiving by Catching Queen ... 91		Feeding in ... .. 108
	Honey ... .. 26		Importance of ... .. 94
	Adulteration of ... .. 28		Season for ... .. 97



	PAGE		PAGE
Raising Cells, Another Method of	108	Surplus Honey, Taking the Last	127
Raising Queen Cells ... ..	95	Supers (Extracted Honey)...	115
Rate of Increase Desirable ... ..	89	Swarms, Decamping ... ..	89
Returning Queen and Brood ... ..	95	Issue of the ... ..	89
Reversible Basket Extractors ... ..	71	Preparation for ... ..	87
Ripening and Maturing Tanks... ..	122	Prevention of After ... ..	92
Extracted Honey ... ..	120	Size of ... ..	87
Inside and Outside Hive ... ..	121	Taking and Hiving ... ..	89
Robbing ... ..	129	Swarming, Cause of ... ..	86
To Stop, ... ..	130	Cells ... ..	107
Saccharine Matter of Plants not		Prevention of ... ..	91
Derived from the Soil ... ..	157	Symptoms of ... ..	88
From Atmosphere and Rain		Swarming-Out, To Prevent ... ..	139
Water ... ..	157	Top Boxes ... ..	111
Saving Healthy Brood ... ..	140	Additional ... ..	117
Seasons, Variability of ... ..	166	Spare ... ..	132
Section Boxes ... ..	64	Uncapping Cans ... ..	74
Holders ... ..	63	Knives ... ..	74
Securing Covers in Winter ... ..	133	Uniting ... ..	115
Drone Comb ... ..	97	Uniting ... ..	129
Selected Eggs ... ..	98	Water ... ..	40
Separators ... ..	64	Wax, Adulteration of: How to	
Shelter ... ..	39	Detect ... ..	30
Smokers, Fuel for ... ..	78	Presses ... ..	33
Solar Wax Extractor ... ..	34	White Clover Honey, ... ..	149
Spraying Fruit Trees ... ..	151	Will it Pay to Raise Beeswax? 31	
Spring Feeding ... ..	112	Winter Food Supply ... ..	131
Management ... ..	111	Preparing for ... ..	131
Stimulative Feeding ... ..	113	Securing Covers in ... ..	133
Sting, The ... ..	22	Ventilation ... ..	132
Stings, Cure for ... ..	80	Wiring Frames and Foundation 69	
Structural Organisation ... ..	13	Wood Bases for Queen Cells ... 108	
Sulphuric Acid for Cleaning		Work for the Different Months 166	
Wax ... ..	36	Workers, Laying or Fertile ... ..	24

***New Zealand Farmers' Co-operative  
Association of Canterbury, Ltd. ::***

---

Head Office and Warehouse :—

CASHEL STREET,  
CHRISTCHURCH, NEW ZEALAND.

---

**Australasian Headquarters**

---

FOR

---

**BEE KEEPER'S  
APPLIANCES ..**

---

---

Our stocks contain all the articles mentioned in this Manual. Also

**THE LATEST APPLIANCES, Etc.,**

Manufactured by

**THE A.I. ROOT COMPANY, of America,**

for whom we act as Agents.

---

Our output having become so great

**We claim to be the Largest Dealers in  
Bee Goods in the Australasian Colonies.**

---

Write to-day for our Illustrated Catalogue. Posted free by return mail.  
We are CASH BUYERS of White Clover Extracted Honey & Beeswax.

ADVERTISEMENTS.

---

# YATES' RELIABLE SEEDS



FOR THE  
**Garden**  
AND  
**Farm.**

---

**Grasses**  
AND  
**Clovers.**

---

MANURES.

---

## TREES AND PLANTS.

.. IMPLEMENTS. ..

SPRAY PUMPS FOR HAND OR POWER  
AND SPRAYING MATERIALS.

Catalogues on Application.

---

# ARTHUR YATES & Co.

Seed Merchants and Growers,

... AUCKLAND, N.Z.

ADVERTISEMENTS.

---

The FAMOUS "S. & C." DROPHEAD  
**SEWING MACHINE**  
WARRANTED FOR 10 YEARS.

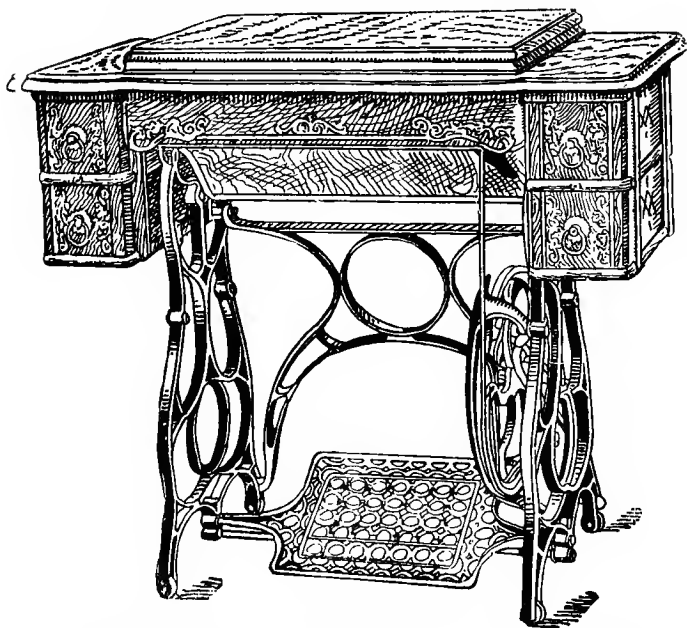

Remarkable  
Value.

**£6 10s. 0d.**

Remarkable  
Value.

Parts and Supplies obtainable all over the World.

---

**SMITH & CAUGHEY, Ltd.,**  
Complete House Furnishers, AUCKLAND.

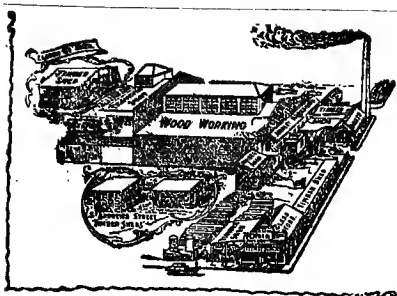

**Attention**  
**Please!**

Are you interested  
in BEES and  
BEE-KEEPING ?

Remember we are the Largest Manufacturers of Beekeepers' Requisites in the Southern Hemisphere, and can supply anything you require.

---

The following is a list of some of our manufactures :

Bee Hives. Bee Frames.  
Honey Extractors (Ball bearing).  
Honey Tanks. Uncapping Cans.  
Patent Cappings' Reducers.

COMB FOUNDATION and all kinds of Beekeepers' Appliances.

All further particulars to be seen in our Fully Illustrated Catalogue. Send us a Post Card and we will send you our Illustrated Catalogue, Postage Free.

---

**ITALIAN AND CYPRIAN QUEENS**

DELIVERED IN ANY PART OF NEW ZEALAND.

Publishers of the "AUSTRALASIAN BEEKEEPER," a Monthly Journal devoted entirely to Bees and Beekeepers' Interests. Price, 5/- per annum. Sample copy free.

---

**PENDER BROS., Ltd.**

**W. MAITLAND, N.S.W.**

ADVERTISEMENTS.

---

Published Monthly.]

[Published Monthly.

.. THE ..

# New Zealand Farmer

Stock and Station Journal,

With which is incorporated the

N.Z. FIELD AND POULTRY

.. AND ..

KENNEL GAZETTE.

IS THE BEST

Illustrated Farmer's and Country Settler's Journal

PUBLISHED IN AUSTRALASIA.

---

Every apiarist in New Zealand who desires to keep up-to-date should read the "Farmer."

The apiary section is conducted by one of the best known experts in the Dominion.

Practical articles on general farming, lime fruit growing, etc., are the features of the paper, in addition to a wealth of beautiful illustrations.

---

ANNUAL SUBSCRIPTION, 10/- (Including Postage).

Single Copies One Shilling.

---

PRINTED AND PUBLISHED BY

**The Brett Printing & Publishing Co., Ltd.,**

Shortland and Fort Streets,

 AUCKLAND.

# THE SOUTH BRITISH

## Insurance Company, Limited.

Capital	... ..	£2,000,000
Paid-up Capital, Reinsurance, General Reserve and Accumulated Funds amount to	... ..	£600,000

### FIRE DEPARTMENT

Fire risks of every description accepted at Lowest Current Rates, including damage to property caused by Bush Fires and Lightning.

### MARINE DEPARTMENT

Marine risks of every description accepted at Lowest Current Rates. Wool insured from Sheep's back to final port of destination.

### ACCIDENT DEPARTMENT

The following risks are accepted at Lowest Current Rates, viz.: Mortgagees' Indemnity, Employers' Liability, Workers' Compensation, Ordinary Accident, Public Risk, Plate Glass, Burglary, Fidelity Guarantee, Administration Bonds.

The South British Company's "UP-TO-DATE" Policy, combining Accident and Sickness Benefits, is a most liberal and attractive one.

The Company is noted for its prompt and equitable adjustment of losses.

### FARMERS!

Remember your liability under the Employers' Liability and Workers' Compensation Acts, and insure your farm hands with this Company, and save yourselves from loss arising thereunder.

Agents in all Country Towns and Districts.

**A. S. RUSSELL, Manager** ... .. **Auckland**

ADVERTISEMENTS.

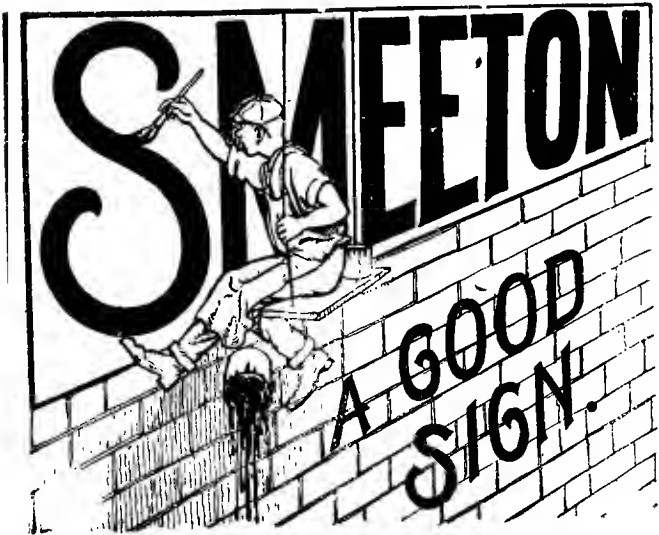

THE HOME OF SMEETON'S  
.. FAMOUS LOW PRICES. ..

---

**H. M. SMEETON, Ltd.,**

General ..

Providers, .

Queen Street, AUCKLAND.



Headquarters for Bee-Keeping Supplies of the most approved, reliable, and up-to-date description.

**THE ALLIANCE  
BOX CO., LTD.,  
Castle Street, Dunedin.**

Manufacturers of the Famous "Alliance" Bee Hives, Frames, etc., and Importers of all Apiarian requisites and appliances.

AGENTS THROUGHOUT THE DOMINION.

Illustrated catalogue post free on application.

**SPECIALITE.** The New Dove-Tailed Hive with Hoffman Frames. The most perfect and economical Hive in the World to-day! Thousands in use throughout the United States. Send for particulars.

N.Z. AGENTS FOR THE A. I. ROOT CO.

**Queens.**

**Queens.**

Leather Colour and Cypro-Italians (Golden).

Untested Queens	...	...	one	three	five	ten
			5/-	13/-	20/-	39/-
Select Untested Queens	...	...	6/-	16/-	25/-	49/-
Warranted Queens	...	...	6/-	16/-	25/-	49/-
Tested Queens	...	...	8/-	22/-	35/-	65/-
Select Tested Queens	...	...	15/-	42/-	65/-	

THE Leather Colour, or 3-banded, are bred at my Federal Apiary, and the Cypro-Italian are bred at my Rosaville Apiary. These apiaries are of sufficient distance apart to prevent the mingling of the drones of the different strains.

**M. ARMSTRONG,**

Rosaville Apiary. Post address, P.O. West Maitland.

ADVERTISEMENTS.

# MACKAY'S

∴ SEEDS, PLANTS, ∴  
BULBS AND FLOWERS

ARE ALWAYS RELIABLE.

---

---

NEW VEGETABLE SEEDS. NEW  
FLOWER SEEDS. SEED POTATOES.  
NEW FARM SEEDS. MANURES.  
✿ NURSERY STOCK OF EVERY ✿  
: : : DESCRIPTION. : : :

---

---

... AGENT FOR ...

LIPPIATT'S ROSES,  
PRATT'S POULTRY FOOD. PRATT'S  
ANIMAL REGULATOR. SPECIAL PARROT  
FOOD. BIRD SEEDS.



Everything for the Garden and Farm,  
At GILBERT J. MACKAY'S,  
SEEDSMAN AND FLORIST,  
106, QUEEN STREET, AUCKLAND.

Opposite Bank N.Z. new premises.

New Catalogue just issued, post free on application.

If you have  
**BEES WAX**  
— TO SELL, —

. . . Write to . . .

**Sharland & Co., Ltd.,**  
**Lorne Street, Auckland.**

---

WE ARE CASH BUYERS OF

**BEESWAX**

IN ANY QUANTITIES.

**KENDERDINE & KIRKUP,**  
SALE STREET, AUCKLAND.

---

**JOHN REID & CO.**

EXPORTERS OF . . . .  
NEW ZEALAND PRODUCE,

43 & 45, Fort Street, Auckland.

We Export **BEESWAX**, Wool, Timber, Gum, Fungus, Maize, Oils,  
Limejuice, Whalebone, Bark, &c.

ESTABLISHED 41 YEARS.

# HONEY TINS.

Having installed a most up-to-date Automatic Can-making Plant, we can supply the above in any sizes at Bedrock Prices. We now make the 2-lb. Honey Tins with Double Seamed ends and no Solder is used in the making up of these. This ensures the tin keeping bright and clean.

—WRITE FOR PRICES.—



## Alexander Harvey & Sons,

Manufacturers of PLAIN and DECORATED TINS of every description for Fruit, Honey, Jam, Fish, Butter, Spice, Tea, Coffee, Baking Powder, &c.

—ALBERT STREET, AUCKLAND.—

---

## A. J. ENTRICAN & CO.,

LIMITED,

Custom and Gore  
Streets,

AUCKLAND,

Wholesale Grocers  
and Confectioners..

---

---

Importers and General Merchants.

Agents for Trapp's Honey. Sole Agents for Hutchison's and Hobb's White Clover Honey.

N.B.—We are Cash Buyers of Honey and Beeswax in any quantity. Correspondence invited. Submit Sample when writing.

---

## **A WORD TO BEEKEEPERS!**

Do you want to double the output from your  
Apiary? If so, you must have

# **GOOD ITALIAN QUEENS**

I supply none but the **VERY BEST**,  
——— and the Prices are right. ——

Untested, 4/- each. Ten for 35/-. Twenty for 60/-.  
Tested, 7/6 each. Three for 20/-. Select Tested, 12/6 each.

Write for Catalogue and further particulars.

---

—❧— **A. J. D'ARCY**, ❧—

20, LINTON ST., PALMERSTON NORTH.

---

## **W. ABRAM & SON.**

**The First Italian Bee Farm in Australia.**

ESTABLISHED 1881.

Breeders of Italian Queens of various Strains their Speciality. Foundation  
and all other Bee goods supplied. Price List on Application, free.

**W. ABRAM & SON,**

The Italian Bee Farm, BEECROFT, Near Sydney,  
New South Wales.

---

## **KEEP BEES**

**THAT WILL KEEP YOU!!!  
I CAN HELP YOU TO GET  
——— THEM. ——**

Send for my price list of Queens by post; it's  
mailed to you free, on receipt of your address.

**R. STEWART,** Crookston, Otago,  
**NEW ZEALAND.**

.. The ..  
**New Zealand  
Express Co.,  
Limited.**

CORRESPONDENCE INVITED.

ESTABLISHED 1867.



## Have you Bees you want forwarded ?

If you have hives of bees you want forwarded you cannot do better than employ us. We'll collect them, or, if more convenient, they may be consigned to us. Every care will be given to them while in our hands, and we'll see to their getting to their destination in the safest and speediest manner. Read what a constant client says. We can satisfy you equally well.

Epsom.

To the Manager N.Z. Express Co., Auckland.—Dear Sir,—I have great pleasure in informing you that out of the large number of colonies of bees, and coops of Homing Pigeons sent by me through your Company to all parts of New Zealand during the past number of years, not one mishap has occurred, which speaks well for the care taken by yourself and your agents.  
Yours truly, I. Hopkins.

Write for particulars of our service.

## THE N.Z. EXPRESS COMPANY, LIMITED,

Carriers, Customs, and Express Forwarding Agents.

OFFICES:—Auckland, Wellington, Christchurch, Dunedin, Invercargill, Gore, Oamaru, Timaru, Lyttelton, Palmerston North, New Plymouth, and Wanganui. And 100 Agencies in other Towns.

### Instructions for packing & forwarding Bees, by Government Expert.

In packing hives of Bees for transit, first of all see that the frames of combs are well secured and the proper distance apart. Hoffman Self Spacing Frames, and old tough combs are the most suitable. Next see that the hive is well ventilated both at top and bottom—spaces of at least six inches square covered with wire gauze 16 meshes to the lineal inch—should be provided in the temporary bottom board and cover. Tie a piece of sponge to the top wire gauze and paste instructions on the hive to wet the sponge once a day with clean water. Don't put in any brood, or overcrowd with bees, put on a good readable address, and communicate with your nearest N.Z. Express Co. Office.













